

Programmable Controller

MELSEC **Q**series MELSEC *L*series

QnUDVCPU/LCPU User's Manual (Data Logging Function)

- Q03UDVCPU
- Q04UDVCPU
- Q04UDPVCPU
- Q06UDVCPU
- Q06UDPVCPU
- Q13UDVCPU
- Q13UDPVCPU
- Q26UDVCPU
- Q26UDPVCPU
- L02CPU
- L02CPU-P
- L06CPU
- L06CPU-P
- L26CPU
- L26CPU-P
- L26CPU-BT
- L26CPU-PBT

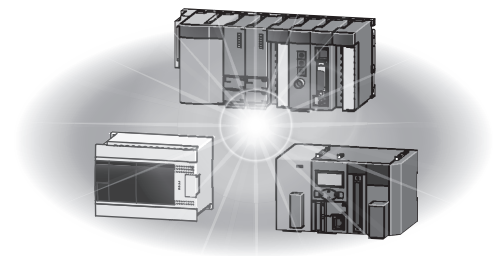

● SAFETY PRECAUTIONS ●

(Read these precautions before using this product.)

Before using this product, please read this manual and the relevant manuals carefully and pay full attention to safety to handle the product correctly.

In this manual, the safety precautions are classified into two levels: "⚠ WARNING" and "⚠ CAUTION".



Indicates that incorrect handling may cause hazardous conditions, resulting in death or severe injury.



Indicates that incorrect handling may cause hazardous conditions, resulting in minor or moderate injury or property damage.

Under some circumstances, failure to observe the precautions given under "⚠ CAUTION" may lead to serious consequences.

Observe the precautions of both levels because they are important for personal and system safety.

Make sure that the end users read this manual and then keep the manual in a safe place for future reference.

[Design Precautions]

WARNING

- Configure safety circuits external to the programmable controller to ensure that the entire system operates safely even when a fault occurs in the external power supply or the programmable controller. Failure to do so may result in an accident due to an incorrect output or malfunction.
 - (1) Emergency stop circuits, protection circuits, and protective interlock circuits for conflicting operations (such as forward/reverse rotations or upper/lower limit positioning) must be configured external to the programmable controller.
 - (2) Machine OPR (Original Point Return) of the positioning function is controlled by two kinds of data: an OPR direction and an OPR speed. Deceleration starts when the near-point watchdog signal turns on. If an incorrect OPR direction is set, motion control may continue without deceleration. To prevent machine damage caused by this, configure an interlock circuit external to the programmable controller.
 - (3) When the CPU module detects an error during control by the positioning function, the motion slows down and stops.
 - (4) The programmable controller stops its operation upon detection of the following status, and the output status of the system will be as shown below.

	Q/L series module	AnS/A series module
Overcurrent or overvoltage protection of the power supply module is activated.	All outputs are turned off	All outputs are turned off
The CPU module detects an error such as a watchdog timer error by the self-diagnostic function.	All outputs are held or turned off according to the parameter setting.	All outputs are turned off

Also, all outputs may be turned on if an error occurs in a part, such as an I/O control part, where the programmable controller CPU cannot detect any error. To ensure safety operation in such a case, provide a safety mechanism or a fail-safe circuit external to the programmable controller. For a fail-safe circuit example, refer to the User's Manual (Hardware Design, Maintenance and Inspection) for the CPU module used.

- (5) Outputs may remain on or off due to a failure of a component such as a transistor in an output circuit. Configure an external circuit for monitoring output signals that could cause a serious accident.
- In an output circuit, when a load current exceeding the rated current or an overcurrent caused by a load short-circuit flows for a long time, it may cause smoke and fire. To prevent this, configure an external safety circuit, such as a fuse.
 - Configure a circuit so that the programmable controller is turned on first and then the external power supply. If the external power supply is turned on first, an accident may occur due to an incorrect output or malfunction.
 - Configure a circuit so that the external power supply is turned off first and then the programmable controller. If the programmable controller is turned off first, an accident may occur due to an incorrect output or malfunction.
 - For the operating status of each station after a communication failure, refer to relevant manuals for each network. Incorrect output or malfunction due to a communication failure may result in an accident.

WARNING

- When changing data from a peripheral device connected to the CPU module during operation, configure an interlock circuit in the program to ensure that the entire system will always operate safely. For other controls to a running programmable controller (such as program modification or operating status change), read relevant manuals carefully and ensure the safety before the operation. Especially, in the case of a control from an external device to a remote programmable controller, immediate action cannot be taken for a problem on the programmable controller due to a communication failure. To prevent this, configure an interlock circuit in the program, and determine corrective actions to be taken between the external device and CPU module in case of a communication failure.
- An absolute position restoration by the positioning function may turn off the servo-on signal (servo off) for approximately 20ms, and the motor may run unexpectedly. If this causes a problem, provide an electromagnetic brake to lock the motor during absolute position restoration.

[Design Precautions]

CAUTION

- Do not install the control lines or communication cables together with the main circuit lines or power cables. Keep a distance of 100mm or more between them. Failure to do so may result in malfunction due to noise.
- During control of an inductive load such as a lamp, heater, or solenoid valve, a large current (approximately ten times greater than normal) may flow when the output is turned from off to on. Therefore, use a module that has a sufficient current rating.
- After the CPU module is powered on or is reset, the time taken to enter the RUN status varies depending on the system configuration, parameter settings, and/or program size. Design circuits so that the entire system will always operate safely, regardless of the time.

[Installation Precautions]

WARNING

- Shut off the external power supply (all phases) used in the system before mounting or removing a module. Failure to do so may result in electric shock or cause the module to fail or malfunction.

[Installation Precautions]

CAUTION

- Use the programmable controller in an environment that meets the general specifications in the User's Manual (Hardware Design, Maintenance and Inspection) for the CPU module used. Failure to do so may result in electric shock, fire, malfunction, or damage to or deterioration of the product.
- To mount the module, while pressing the module mounting lever in the lower part of the module, fully insert the module fixing projection(s) into the hole(s) in the base unit and press the module until it snaps into place. Incorrect interconnection may cause malfunction, failure, or drop of the module. When using the programmable controller in an environment of frequent vibrations, fix the module with a screw. Tighten the screws within the specified torque range. Undertightening can cause drop of the screw, short circuit, or malfunction. Overtightening can damage the screw and/or module, resulting in drop, short circuit, or malfunction.
- When using an extension cable, connect it to the extension cable connector of the base unit securely. Check the connection for looseness. Poor contact may cause incorrect input or output.
- When using an SD memory card, fully insert it into the SD memory card slot. Check that it is inserted completely. Poor contact may cause malfunction.
- Securely insert an extended SRAM cassette into the cassette connector of a CPU module. After insertion, close the cassette cover to prevent the cassette from coming off. Failure to do so may cause malfunction.
- To interconnect modules, engage the respective connectors and securely lock the module joint levers until they click.
- Do not directly touch any conductive parts and electronic components of the module. Doing so can cause malfunction or failure of the module.
- Securely connect an extension cable to the connectors of a branch module and an extension module. After connections, check that the cable is inserted completely. Poor contact may cause malfunction.

[Wiring Precautions]

WARNING

- Shut off the external power supply (all phases) used in the system before wiring. Failure to do so may result in electric shock or cause the module to fail or malfunction.
- After installation and wiring, attach the included terminal cover to the module before turning it on for operation. Failure to do so may result in electric shock.

[Wiring Precautions]

CAUTION

- Individually ground the FG and LG terminals of the programmable controller with a ground resistance of 100 ohms or less. Failure to do so may result in electric shock or malfunction.
- Use applicable solderless terminals and tighten them within the specified torque range.
If any spade solderless terminal is used, it may be disconnected when a terminal block screw comes loose, resulting in failure.
- Check the rated voltage and terminal layout before wiring to the module, and connect the cables correctly. Connecting a power supply with a different voltage rating or incorrect wiring may cause a fire or failure.
- Connectors for external devices must be crimped or pressed with the tool specified by the manufacturer, or must be correctly soldered. Incomplete connections may cause short circuit, fire, or malfunction.
- Securely connect the connector to the module. Poor contact may result in malfunction.
- Do not install the control lines or communication cables together with the main circuit lines or power cables. Keep a distance of 100mm or more between them. Failure to do so may result in malfunction due to noise.
- Place the cables in a duct or clamp them. If not, dangling cable may swing or inadvertently be pulled, resulting in damage to the module or cables or malfunction due to poor contact.
- Check the interface type and correctly connect the cable. Incorrect wiring (connecting the cable to an incorrect interface) may cause failure of the module and external device.
- Tighten the terminal block screws within the specified torque range. Undertightening can cause short circuit, fire, or malfunction. Overtightening can damage the screw and/or module, resulting in drop, short circuit, or malfunction.
- When disconnecting the cable from the module, do not pull the cable by the cable part. For the cable with connector, hold the connector part of the cable. For the cable connected to the terminal block, loosen the terminal screw. Pulling the cable connected to the module may result in malfunction or damage to the module or cable.
- Prevent foreign matter such as dust or wire chips from entering the module. Such foreign matter can cause a fire, failure, or malfunction.
- A protective film is attached to the top of the module to prevent foreign matter, such as wire chips, from entering the module during wiring. Do not remove the film during wiring. Remove it for heat dissipation before system operation.
- To use the high-speed counter function, ground the shield cable on the encoder side (relay box). Failure to do so may cause malfunction.
- Mitsubishi Electric programmable controllers must be installed in control panels. Connect the main power supply to the power supply module in the control panel through a relay terminal block. Wiring and replacement of a power supply module must be performed by qualified maintenance personnel with knowledge of protection against electric shock.
For wiring methods, refer to the User's Manual (Hardware Design, Maintenance and Inspection) for the CPU module used.

[Startup and Maintenance Precautions]

WARNING

- Do not touch any terminal while power is on. Doing so will cause electric shock or malfunction.
- Correctly connect the battery connector. Do not charge, disassemble, heat, short-circuit, solder, or throw the battery into the fire. Also, do not expose it to liquid or strong shock.
Doing so will cause the battery to produce heat, explode, ignite, or leak, resulting in injury and fire.
- Shut off the external power supply (all phases) used in the system before cleaning the module or retightening the terminal block screws, connector screws, or module fixing screws. Failure to do so may result in electric shock or cause the module to fail or malfunction.

[Startup and Maintenance Precautions]

CAUTION

- Before performing online operations (especially, program modification, forced output, and operating status change) for the running CPU module from the peripheral device connected, read relevant manuals carefully and ensure the safety. Improper operation may damage machines or cause accidents.
- Do not disassemble or modify the modules. Doing so may cause failure, malfunction, injury, or a fire.
- Use any radio communication device such as a cellular phone or PHS (Personal Handy-phone System) more than 25cm away in all directions from the programmable controller. Failure to do so may cause malfunction.
- Shut off the external power supply (all phases) used in the system before mounting or removing a module. Failure to do so may cause the module to fail or malfunction.
- Tighten the terminal block screws within the specified torque range. Undertightening can cause drop of the component or wire, short circuit, or malfunction. Overtightening can damage the screw and/or module, resulting in drop, short circuit, or malfunction.
- After the first use of the product (module, display unit, and terminal block), do not connect/disconnect the product, do not mount/remove the module to/from the base unit, and do not insert/remove the extended SRAM cassette to/from the CPU module more than 50 times (in accordance with IEC 61131-2). Exceeding the limit may result in malfunction.
- After the first use of the product, do not insert/remove the SD memory card to/from the CPU module more than 500 times. Exceeding the limit may cause malfunction.
- Do not drop or apply shock to the battery to be installed in the module. Doing so may damage the battery, causing the battery fluid to leak inside the battery. If the battery is dropped or any shock is applied to it, dispose of it without using.
- Before handling the module, touch a conducting object such as a grounded metal to discharge the static electricity from the human body. Failure to do so may cause the module to fail or malfunction.
- Before testing the operation by the positioning function, set a low speed value for the speed limit parameter so that the operation can be stopped immediately upon occurrence of a hazardous condition.

[Disposal Precautions]

 **CAUTION**

- When disposing of this product, treat it as industrial waste. When disposing of batteries, separate them from other wastes according to the local regulations. (For details on battery regulations in EU member states, refer to the User's Manual (Hardware Design, Maintenance and Inspection) for the CPU module used.)

[Transportation Precautions]

 **CAUTION**

- When transporting lithium batteries, follow the transportation regulations. (For details on the regulated models, refer to the User's Manual (Hardware Design, Maintenance and Inspection) for the CPU module used.)

● CONDITIONS OF USE FOR THE PRODUCT ●

- (1) Mitsubishi programmable controller ("the PRODUCT") shall be used in conditions;
 - i) where any problem, fault or failure occurring in the PRODUCT, if any, shall not lead to any major or serious accident; and
 - ii) where the backup and fail-safe function are systematically or automatically provided outside of the PRODUCT for the case of any problem, fault or failure occurring in the PRODUCT.

- (2) The PRODUCT has been designed and manufactured for the purpose of being used in general industries.

MITSUBISHI SHALL HAVE NO RESPONSIBILITY OR LIABILITY (INCLUDING, BUT NOT LIMITED TO ANY AND ALL RESPONSIBILITY OR LIABILITY BASED ON CONTRACT, WARRANTY, TORT, PRODUCT LIABILITY) FOR ANY INJURY OR DEATH TO PERSONS OR LOSS OR DAMAGE TO PROPERTY CAUSED BY the PRODUCT THAT ARE OPERATED OR USED IN APPLICATION NOT INTENDED OR EXCLUDED BY INSTRUCTIONS, PRECAUTIONS, OR WARNING CONTAINED IN MITSUBISHI'S USER, INSTRUCTION AND/OR SAFETY MANUALS, TECHNICAL BULLETINS AND GUIDELINES FOR the PRODUCT.

("Prohibited Application")

Prohibited Applications include, but not limited to, the use of the PRODUCT in;

- Nuclear Power Plants and any other power plants operated by Power companies, and/or any other cases in which the public could be affected if any problem or fault occurs in the PRODUCT.
- Railway companies or Public service purposes, and/or any other cases in which establishment of a special quality assurance system is required by the Purchaser or End User.
- Aircraft or Aerospace, Medical applications, Train equipment, transport equipment such as Elevator and Escalator, Incineration and Fuel devices, Vehicles, Manned transportation, Equipment for Recreation and Amusement, and Safety devices, handling of Nuclear or Hazardous Materials or Chemicals, Mining and Drilling, and/or other applications where there is a significant risk of injury to the public or property.

Notwithstanding the above, restrictions Mitsubishi may in its sole discretion, authorize use of the PRODUCT in one or more of the Prohibited Applications, provided that the usage of the PRODUCT is limited only for the specific applications agreed to by Mitsubishi and provided further that no special quality assurance or fail-safe, redundant or other safety features which exceed the general specifications of the PRODUCTS are required. For details, please contact the Mitsubishi representative in your region.

INTRODUCTION

Thank you for purchasing the Mitsubishi Electric MELSEC-Q or -L series programmable controllers.

This manual describes the data logging function of the High-speed Universal model QCPU, Universal model Process CPU, and the LCPU. It also describes the configuration tool for data logging.

Before using this product, please read this manual and the relevant manuals carefully and develop familiarity with the functions and performance of the MELSEC-Q or -L series programmable controller to handle the product correctly.

When applying the program examples introduced in this manual to the actual system, ensure the applicability and confirm that it will not cause system control problems.

■ Relevant CPU modules

CPU module	Type name
High-speed Universal model QCPU	Q03UDVCPU, Q04UDVCPU, Q06UDVCPU, Q13UDVCPU, Q26UDVCPU
Universal model Process CPU	Q04UDPVCPU, Q06UDPVCPU, Q13UDPVCPU, Q26UDPVCPU
LCPU	L02CPU, L02CPU-P, L06CPU, L06CPU-P, L26CPU, L26CPU-P, L26CPU-BT, L26CPU-PBT

Remark

- This manual does not describe the details of the error codes, special relay (SM), and special register (SD). For details, refer to the user's manual for the CPU module used.
 - 📖 QCPU User's Manual (Hardware Design, Maintenance and Inspection)
 - 📖 MELSEC-L CPU Module User's Manual (Hardware Design, Maintenance and Inspection)
- The L02SCPU and L02SCPU-P do not support the data logging function.

RELEVANT MANUALS

(1) CPU module user's manual

Manual name [manual number (model code)]	Description	Available form
QCPU User's Manual (Hardware Design, Maintenance and Inspection) [SH-080483ENG, 13JR73]	Specifications of the CPU modules, power supply modules, base units, extension cables, memory cards, SD memory cards, extended SRAM cassettes, and batteries, information on how to establish a system, maintenance and inspection, and troubleshooting	Print book
		PDF
MELSEC-L CPU Module User's Manual (Hardware Design, Maintenance and Inspection) [SH-080890ENG, 13JZ36]	Specifications of the CPU modules, power supply modules, display unit, branch module, extension module, SD memory cards, and batteries, information on how to establish a system, maintenance and inspection, and troubleshooting	Print book
		e-Manual PDF
QnUCPU User's Manual (Function Explanation, Program Fundamentals) [SH-080807ENG, 13JZ27]	Functions and devices of the CPU module, and programming	Print book
		PDF
MELSEC-L CPU Module User's Manual (Function Explanation, Program Fundamentals) [SH-080889ENG, 13JZ35]	Functions and devices of the CPU module, and programming	Print book
		e-Manual PDF
QnUCPU User's Manual (Communication via Built-in Ethernet Port) [SH-080811ENG, 13JZ29]	Detailed description of the Ethernet function of the CPU module	Print book
		PDF
MELSEC-L CPU Module User's Manual (Built-In Ethernet Function) [SH-080891ENG, 13JZ37]	Detailed description of the Ethernet function of the CPU module	Print book
		e-Manual PDF

(2) Programming manual

Manual name [manual number (model code)]	Description	Available form
MELSEC-Q/L Programming Manual (Common Instruction) [SH-080809ENG, 13JW10]	Detailed description and usage of instructions used in programs	Print book
		e-Manual PDF

(3) Operating manual

Manual name [manual number (model code)]	Description	Available form
GX Works2 Version 1 Operating Manual (Common) [SH-080779ENG, 13JU63]	System configuration, parameter settings, and online operations (common to Simple project and Structured project) of GX Works2	Print book
		PDF
GX Developer Version 8 Operating Manual [SH-080373E, 13JU41]	Operating methods of GX Developer, such as programming, printing, monitoring, and debugging	Print book
		PDF
GX LogViewer Version 1 Operating Manual [SH-080915ENG, 13JU68]	System configuration, functions, and operating methods of GX LogViewer	Print book
		e-Manual PDF



e-Manual refers to the Mitsubishi Electric FA electronic book manuals that can be browsed using a dedicated tool. e-Manual has the following features:

- Required information can be cross-searched in multiple manuals.
- Other manuals can be accessed from the links in the manual.
- The hardware specifications of each part can be found from the product figures.
- Pages that users often browse can be bookmarked.
- Sample programs can be copied to an engineering tool.

Memo

CONTENTS

SAFETY PRECAUTIONS	1
CONDITIONS OF USE FOR THE PRODUCT	8
INTRODUCTION	9
RELEVANT MANUALS	10
MANUAL PAGE ORGANIZATION	16
TERMS	19
<hr/>	
CHAPTER 1 DATA LOGGING	20
<hr/>	
1.1 Features	20
1.2 Processing Outline	25
<hr/>	
CHAPTER 2 SYSTEM CONFIGURATION	26
<hr/>	
2.1 Overall System Configuration	26
2.1.1 Software	27
2.1.2 Connection from a USB or serial port	28
2.1.3 Connection from an interface board	31
2.2 Precautions for Ethernet Connection	32
2.3 Operating Environment for the Configuration Tool	33
<hr/>	
CHAPTER 3 SPECIFICATIONS	34
<hr/>	
3.1 Function Specifications	34
3.2 Folder Structure	36
3.3 CSV File Output Format	37
3.3.1 CSV format specifications	37
3.3.2 Output details of lines and columns	37
3.3.3 Value ranges by output format	42
3.4 Size of Data Logging Setting File	43
<hr/>	
CHAPTER 4 PROCEDURES AND SETTINGS BEFORE SYSTEM OPERATION	44
<hr/>	
CHAPTER 5 START-UP OF THE CONFIGURATION TOOL	46
<hr/>	
5.1 Getting the Configuration Tool	46
5.2 Installing/Uninstalling the Configuration Tool	47
5.3 Starting the Configuration Tool	47
5.4 Switching a Display Language	47
<hr/>	
CHAPTER 6 DATA LOGGING FUNCTION	48
<hr/>	
6.1 Target Data	49
6.2 Sampling of Target Data	50
6.3 Logging Type	56
6.3.1 Continuous logging	56
6.3.2 Trigger logging	57
6.3.3 Specification period logging	61

6.4	Data Logging Status	63
6.5	Data Logging File	64
6.5.1	Saving format of the data logging file	64
6.5.2	How sampled data are saved	64
6.5.3	File switching setting	65
6.6	Buffer Capacity	68
6.7	Data Missing	69
6.8	SD Memory Card Life When the Data Logging Function is Used	71
6.9	Precautions to Take When Using the Data Logging Function	73

CHAPTER 7 OTHER FUNCTIONS	77
----------------------------------	-----------

7.1	Data Logging Operation at Transition to RUN	77
7.2	Auto Logging by Inserting an SD Memory Card	78
7.3	File Access	81
7.4	Data Logging File Transfer Function	82
7.4.1	Procedure overview of the data logging file transfer function	83
7.4.2	Directory structure of the FTP server	84
7.4.3	File transfer status	85
7.4.4	File transfer test	88
7.4.5	File transfer diagnostics	89
7.4.6	Precautions for using the data logging file transfer function	90
7.4.7	Stack logging file transfer	92
7.4.8	Transfer completing/Non-completing file distinction indication	94

CHAPTER 8 HOW TO USE THE CONFIGURATION TOOL	95
--	-----------

8.1	Setting Flow Chart	95
8.2	Window Structure	96
8.2.1	Main window	96
8.2.2	Menu structure	97
8.2.3	Toolbar structure	98
8.2.4	Edit item tree	99
8.2.5	Status bar	100
8.2.6	Common operations	101
8.2.7	Device batch replacement	102
8.3	Project Management	103
8.3.1	Creating a new project	103
8.3.2	Opening a project	103
8.3.3	Saving a project	104
8.3.4	Changing a programmable controller series	105
8.3.5	Reading the data logging setting from the SD memory card	106
8.3.6	Writing the data logging setting to the SD memory card	108
8.4	Data Logging Setting	110
8.4.1	Data logging setting list	110
8.4.2	Change of the data logging setting window	112
8.4.3	Logging type	114

8.4.4	Sampling	115
8.4.5	Data	117
8.4.6	Paste/Insert device copied in other application software	119
8.4.7	Batch data insertion	120
8.4.8	Trigger	121
8.4.9	Specification period	123
8.4.10	Number of logging lines	124
8.4.11	CSV output	125
8.4.12	Save	127
8.4.13	File transfer	129
8.4.14	Movement	131
8.4.15	Finish	132
8.5	Common Setting	133
8.5.1	Auto logging setting	134
8.5.2	Buffer capacity setting	135
8.6	Transfer Setup	136
8.6.1	Connection with a USB or Ethernet cable	136
8.6.2	Connection via a network	138
8.6.3	Connection test	140
8.6.4	Connection channel list	140
8.6.5	Searching CPU modules on the network	141
8.7	Reading the Data Logging Setting from the CPU Module	143
8.8	Writing the Data Logging Setting to the CPU Module	145
8.9	Deleting the Data Logging Setting in the CPU Module	147
8.10	Logging Status and Operation	149
8.11	Logging File Operation	152
8.12	Data Logging File Transfer Status	154
8.13	Checking the Product Information	156
8.13.1	Opening the user's manual	156
8.13.2	Checking the version information	156
8.14	Available Characters	157
8.14.1	Available ASCII characters	157
8.14.2	Characters available for file and folder (directory) names	158
8.14.3	Characters available for the data logging setting	158

CHAPTER 9 SD MEMORY CARD	159
---------------------------------	------------

9.1	Precautions for Using SD Memory Cards	159
-----	---------------------------------------	-----

CHAPTER 10 PROCESSING TIME	161
-----------------------------------	------------

10.1	Data Logging Processing Time	161
10.1.1	Continuous logging, specification period logging	162
10.1.2	Trigger logging	165
10.2	Checking the Processing Time	167
10.2.1	Checking the data logging processing time	167
10.3	Impact on Scan Time	168

10.4	Processing Time of Each Instruction	169
<hr/> CHAPTER 11 DATA LOGGING INSTRUCTIONS		170
11.1	Trigger Logging Set (Reset) (LOGTRG(R))	171
11.2	Data Logging Name Read (SP.LOGNAMER)	173
11.3	Data Logging File Name Addition (SP.LOGFILES)	175
<hr/> CHAPTER 12 SPECIAL RELAY AND SPECIAL REGISTER		178
12.1	Special Relay List	178
12.2	Special Register List	179
<hr/> CHAPTER 13 TROUBLESHOOTING		180
13.1	List of the Errors That May Occur in Data Logging	180
13.2	Troubleshooting by Symptom	183
13.2.1	Troubleshooting on CSV file output	183
13.2.2	Troubleshooting on SD memory cards	183
13.2.3	Troubleshooting on the configuration tool	183
13.2.4	Troubleshooting on the entire system during operation of the data logging function	184
13.2.5	Troubleshooting on the data logging status	185
13.2.6	Troubleshooting on the data logging file transfer function	185
<hr/> APPENDICES		187
Appendix 1	Installing a USB Driver	187
Appendix 2	Added and Changed Functions	190
<hr/> INDEX		192
<hr/> INSTRUCTION INDEX		194
REVISIONS		196
WARRANTY		199
TRADEMARKS		200

MANUAL PAGE ORGANIZATION

In this manual, pages are organized and the symbols are used as shown below.
The following illustration is for explanation purpose only, and should not be referred to as an actual documentation.

"" is used for screen names and items.

1. shows operating procedures.

☞ shows mouse operations.*1

[] is used for items in the menu bar and the project window.

Ex. shows setting or operating examples.

📖 shows reference manuals.

📄 shows reference pages.

Point shows notes that requires attention.

Remark shows useful information.

CHAPTER 7 VARIOUS SETTINGS

7.1.1 Setting method

(1) Setting parameters

(a) Operating procedure

1. Open the "PLC Parameter" dialog box.
Project window ⇨ [Parameter] ⇨ [PLC parameter]
2. Select the "I/O Assignment" tab.

Item	Description	Reference
Type	Select the type of the connected module.	Page 74, Section 7.1.2
Model Name	Select the model name of the connected module.	Page 74, Section 7.1.3
Points	Set the number of points assigned to each slot.	Page 74, Section 7.1.4
Start XY	Specify a start I/O number for each slot.	Page 74, Section 7.1.5
Switch Setting	Configure the switch setting of the built-in I/O or intelligent function modules.	Page 74, Section 7.1.6
Default Values	Set the following: • Error Time Output Mode • PLC Operation Mode at HW Error • I/O Response Time	Page 75, Section 7.1.7

Setting "Start XY" enables modification on the start I/O numbers assigned to connected modules.
Ex. When "1000" is specified in "Start XY" to the slot where a 16-point module is connected, the assignment range of an input module is changed to X1000 to X100F.
For details, refer to the following.
📖 MELSEC-L CPU Module User's Manual (Function Explanation, Program Fundamentals)

Point
Set the type of the connected module in "Type". Setting a different type results in "SPUNIT LAY ERR".
For the intelligent function module, the I/O points must also be the same in addition to the I/O assignment setting.
📄 Page 30, Section 4.2.2)

Remark
When an intelligent module is connected, I/O assignment can be omitted by selecting connected modules from "Intelligent Function Module" in the Project window.

73

*1 The mouse operation example (for GX Works2) is provided below.

Menu bar

Ex. ☞ [Online] ⇨ [Write to PLC...]
Select [Online] on the menu bar, and then select [Write to PLC...].

A window selected in the view selection area is displayed.

Ex. ☞ Project window ⇨ [Parameter] ⇨ [PLC Parameter]
Select [Project] from the view selection area to open the Project window.
In the Project window, expand [Parameter] and select [PLC Parameter].

View selection area

Pages describing instructions are organized as shown below.

The following illustration is for explanation purpose only, and should not be referred to as an actual documentation.

CHAPTER 6 SOCKET COMMUNICATION FUNCTION

6.4.2 Disconnecting a connection (SP.SOCCLDSE)

Execution condition of the instruction

Structure of the instruction in the ladder mode

Shows the devices applicable to the instruction

Setting data	Internal device		JICD		UCIGD	Zn	Constant		Others
	Bit	Word	R, ZR	Bit			Word	K, H	
①	—	○	○	—	—	—	○	—	—
②	—	△ ¹	△ ¹	—	—	—	—	—	—
③	△ ¹	—	△ ¹	—	—	—	—	—	—

*1 File registers set for each local device or program cannot be used.

Setting side
 User : Device value is set by the user.
 System: Device value is set by the CPU module.

Descriptions of setting data and data type

(1) Setting data

Setting data	Description	Set by	Data type
U0	Dummy	—	Character string
①	Connection number (Setting range: 1 to 16)	User	Bit 16-bit
②	Start number of the device from which control data are stored	—	Device name
③	Start number of the device which turns on for one scan upon completion of the instruction ③+1 also turns on when failed.	System	Bit

Descriptions of control data (if any)

(2) Control data

Device	Item	Description	Setting range	Set by
③+0	System area	Completion status is stored	—	—
③+1	Completion status	0000+ Completed Other than 0000+ Failed (Error code)	—	System

63

Detailed descriptions of the instruction

(3) Function

This instruction closes a connection specified in ①. (Disconnection of a connection)
 The result of the SP.SOCCLDSE instruction can be checked with the completion device, ③ + 0 and ③ + 1.

- Completion device ③ + 0
Turns on in the END processing of a scan after completion of the SP.SOCCLDSE instruction, and turns off in the next END processing.
- Completion device ③ + 1
Turns on or off according to the result of the SP.SOCCLDSE instruction.

State	Description
When completed	Remains off.
When failed	Turns on in the END processing of a scan after completion of the SP.SOCCLDSE instruction, and turns off in the next END processing.

Conditions for the error and error codes

(4) Error

A detection of an operation error turns on the Error flag (SM0) and a corresponding error code is stored in SD0 when:

- The connection number specified for ① is other than 1 to 16. (Error code: 4101)
- The device numbers specified for ② and ③ exceed the device point range. (Error code: 4101)
- An invalid device is specified. (Error code: 4004)

For the errors not described in this manual, refer to the following.
 User's Manual (Hardware Design, Maintenance and Inspection) for the CPU module used

(5) Program example

When M2000 is turned on or when the connected device disconnects connection No. 1, connection No. 1 is disconnected by the following program.



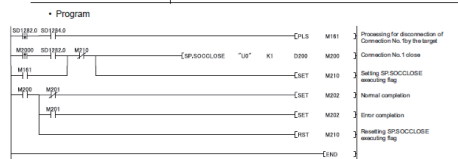

Device used

Device number	Application
SD1252	Open completion signal
SD1254	Open request signal
D200	SP.SOCCLDSE instruction control data
MD00	SP.SOCCLDSE instruction completion device



Simple program example(s) and descriptions of the devices used

- Instructions can be executed under the following conditions.

Execution condition	Any time	During on	On the rising edge	During off	On the falling edge
Symbol	No symbol				

- The following devices can be used.

Setting data	Internal device (system, user)		File register	Link direct device ^{*4} J□\□		Intelligent function module device U□\G□	Index register Zn	Constant ^{*5}	Others ^{*5}
	Bit	Word		Bit	Word				
Applicable device ^{**1}	X, Y, M, L, SM, F, B, SB, FX, FY ^{*2}	T, ST, C, ^{*3} D, W, SD, SW FD ^{*2} , @□	R, ZR	J□\X, J□\Y, J□\B, J□\SB	J□\W, J□\SW	U□\G□	Z	K, H, E, \$	P, I, J, U, DX, DY, N, BL, TR, BLIS, V

*1 For details on each device, refer to the following.

 User's Manual (Function Explanation, Program Fundamentals) for the CPU module used

*2 FX and FY can be used for bit data only, and FD for word data only.

*3 When T, ST, and C are used in an instruction other than the following, they are used as word devices.

Instructions that T, ST, and C are used as bit devices: LD, LDI, AND, ANI, OR, ORI, LDP, LDF, ANDP, ANDF, ORP, ORF, OUT, and RST

*4 These devices can be used in the CC-Link IE Field Network, CC-Link IE Controller Network, MELSECNET/H, and MELSECNET/10.

*5 In the "Constant" and "Others" columns, a device(s) that can be set for each instruction is shown.

- The following data types can be used.

Data type	Description
Bit	Bit data or the start number of bit data
BIN 16-bit	16-bit binary data or the start number of word device
BIN 32-bit	32-bit binary data or the start number of double-word device
BCD 4-digit	Four-digit binary-coded decimal data
BCD 8-digit	Eight-digit binary-coded decimal data
Real number	Floating-point data
String	Character string data
Device name	Device name data

TERMS

Unless otherwise specified, this manual uses the following terms.

Term	Description
Configuration tool	Another term for the CPU Module Logging Configuration Tool
CPU module	A generic term for the High-speed Universal model QCPU, Universal model Process CPU, and the LCPU
CPU Module Logging Configuration Tool	Software to configure data logging settings and to manage collected data
Display unit	A liquid crystal display to be attached to the LCPU
GX Developer	The product name of the software package for the MELSEC programmable controllers
GX Works2	
GX LogViewer	
LCPU	A generic term for the L02CPU, L02CPU-P, L06CPU, L06CPU-P, L26CPU, L26CPU-P, L26CPU-BT, and L26CPU-PBT
Programming tool	A generic term for GX Works2 and GX Developer
Universal model Process CPU	A generic term for the Q04UDPVCPU, Q06UDPVCPU, Q13UDPVCPU, and Q26UDPVCPU
QnUDPVCPU	
High-speed Universal model QCPU	A generic term for the Q03UDVCPU, Q04UDVCPU, Q06UDVCPU, Q13UDVCPU, and Q26UDVCPU
QnUDVCPU	
SD memory card	Secure Digital Memory Card, which is a flash memory device. The NZ1MEM-2GBSD, NZ1MEM-4GBSD, NZ1MEM-8GBSD, NZ1MEM-16GBSD, L1MEM-2GBSD, and L1MEM-4GBSD are available.

CHAPTER 1 DATA LOGGING

The data logging function of the CPU module stores collected device data on an SD memory card in CSV format, with just a simple setting.

1.1 Features

The following explains the features of the data logging function.

(1) Logging of device data is easy.

No program needs to be created for logging. Device data can be logged by only setting parameters. Logged data can be stored on an SD memory card in CSV format.

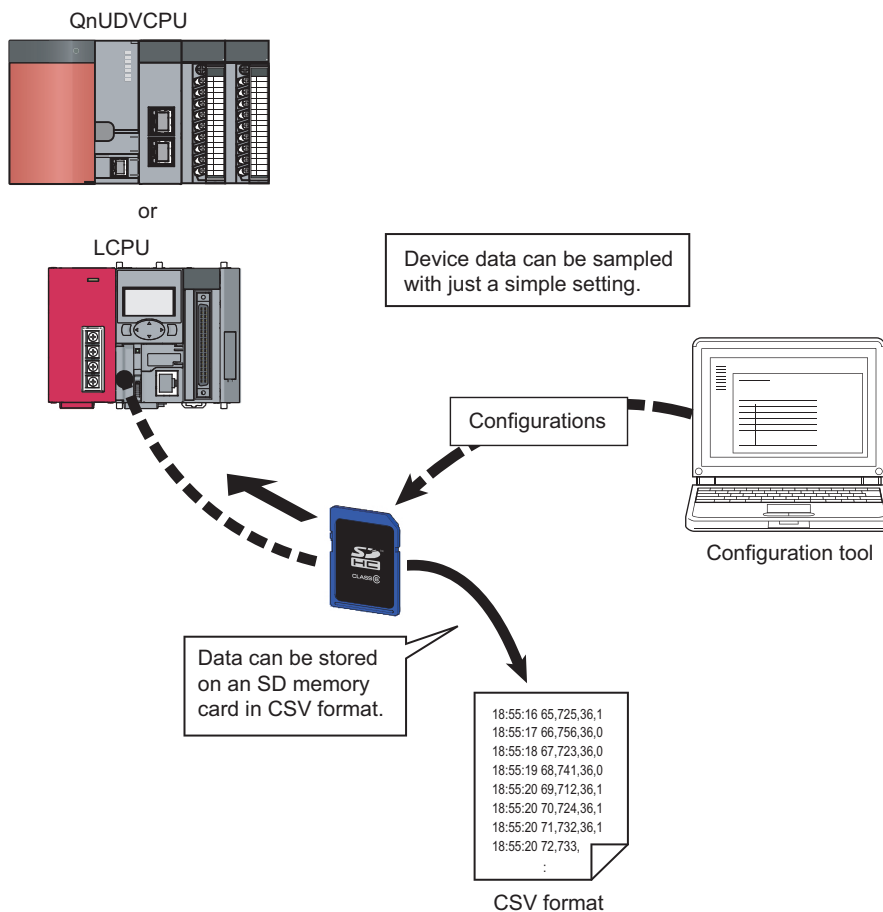

(2) Control data can be logged without missing a change (continuous logging).

Data logging is available every scan or on the millisecond time scale. Since changes in the specified control data can be logged, the data logging function is effective to identify the cause of a problem. Also, logging is performed at a high speed so that equipment can be analyzed with high accuracy.

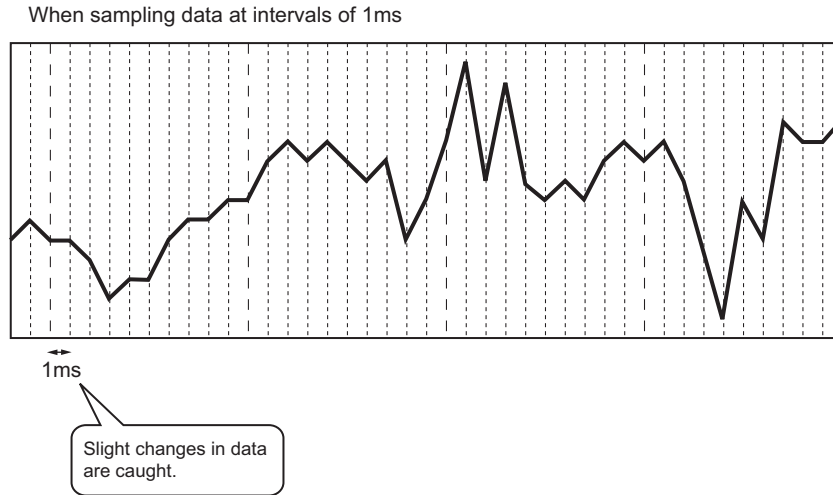

Point

Data logging is the best-effort type*1 function. Logging may not be performed at a specified sampling interval because processing time may vary depending on the configuration or the other connected devices. After configuring the system, thoroughly examine the processing time before starting the system operation. (☞ Page 161, CHAPTER 10)

*1 The concept of obtaining the maximum performance from the condition at the time.

(3) Problem analysis can be speeded up. (Trigger logging)

The states and changes in data can be stored as the data before and after a trigger. Since only the data before and after occurrence of each problem can be stored, the cause of the problem can be identified quickly, and file space can be saved.

:	:	:	:	:
2008/1/10 14:25:34	150	18	356	39
2008/1/10 14:25:34	200	18	330	39
2008/1/10 14:25:34	250	19	280	39
2008/1/10 14:25:34	300	18	310	42
2008/1/10 14:25:34	350	18	300	43
2008/1/10 14:25:34	400	19	285	46
2008/1/10 14:25:34	450	18	290	47
2008/1/10 14:25:34	500	15	310	48
2008/1/10 14:25:34	550	12	312	49
2008/1/10 14:25:34	600	11	333	50
2008/1/10 14:25:34	650	5	340	50
2008/1/10 14:25:34	700	3	352	51
2008/1/10 14:25:34	750	12	360	51
2008/1/10 14:25:34	800	14	362	50
2008/1/10 14:25:34	850	17	363	50
2008/1/10 14:25:34	900	18	363	50
2008/1/10 14:25:34	950	19	365	49
2008/1/10 14:25:35	0	18	370	49
:	:	:	:	:

Annotations: 'Data before trigger' (rows 2-11), 'Trigger occurred' (row 12), 'Data after trigger' (rows 13-20). A vertical double-headed arrow on the right indicates the 'Range of the data stored in a file' covering rows 2 through 20.

(4) Only the specific data can be collected in each file (specification period logging).

Using the specification period logging (☞ Page 61, Section 6.3.3), data can be collected only while the specific conditions are met, and files can be saved for each specified period.

Capacity increase resulting from collecting unnecessary data can thus be prevented, and time taken to analyze and organize data can also be shortened. Even when the conditions change, all data that meet the changed conditions can be collected.

Furthermore, together with the data logging file name addition instruction (SP.LOGFILES) (☞ Page 175, Section 11.3), the specification period logging allows any character to be added to the data logging results for each specified period, facilitating the control of data logging files.

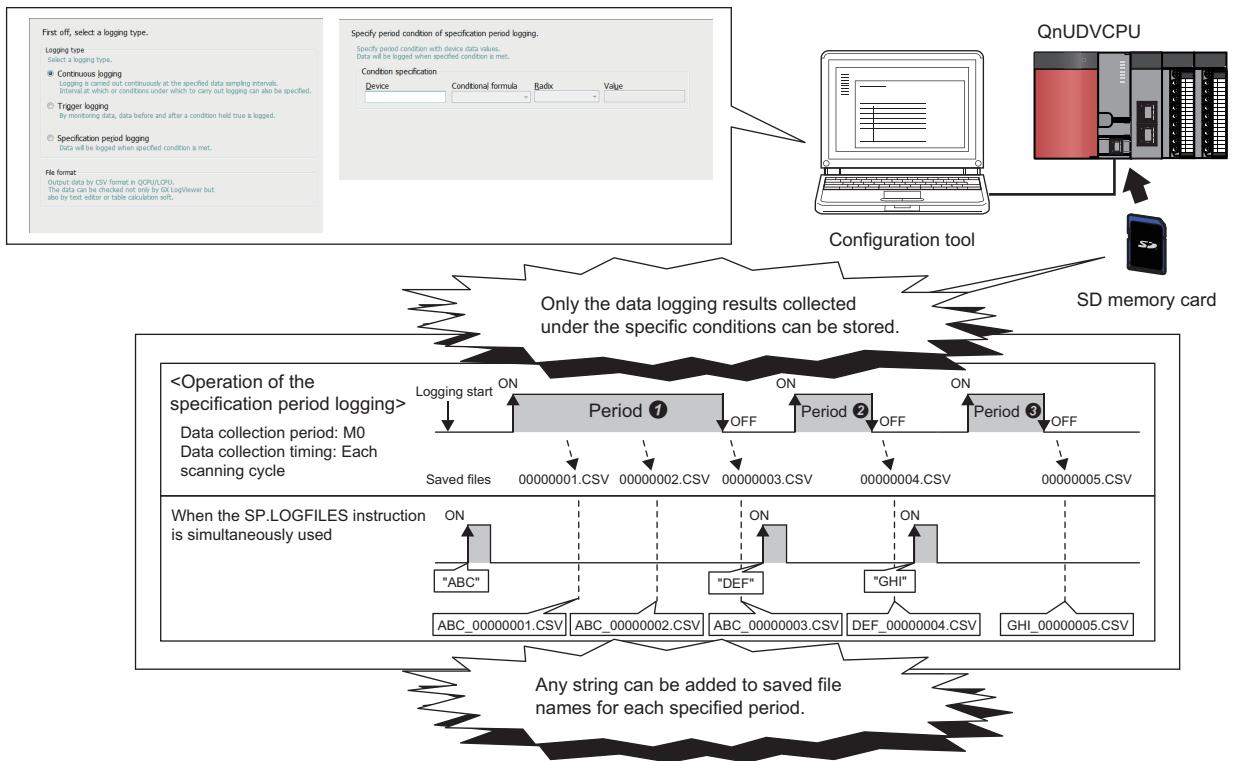

Remark

The specification period logging is available only for the High-speed Universal model QCPU and the Universal model Process CPU. Before using the specification period logging, check the versions of the CPU module and configuration tool used. (☞ Page 190, Appendix 2)

(5) Configuration for logging is simple.

Logging settings can be configured easily by following the wizard.

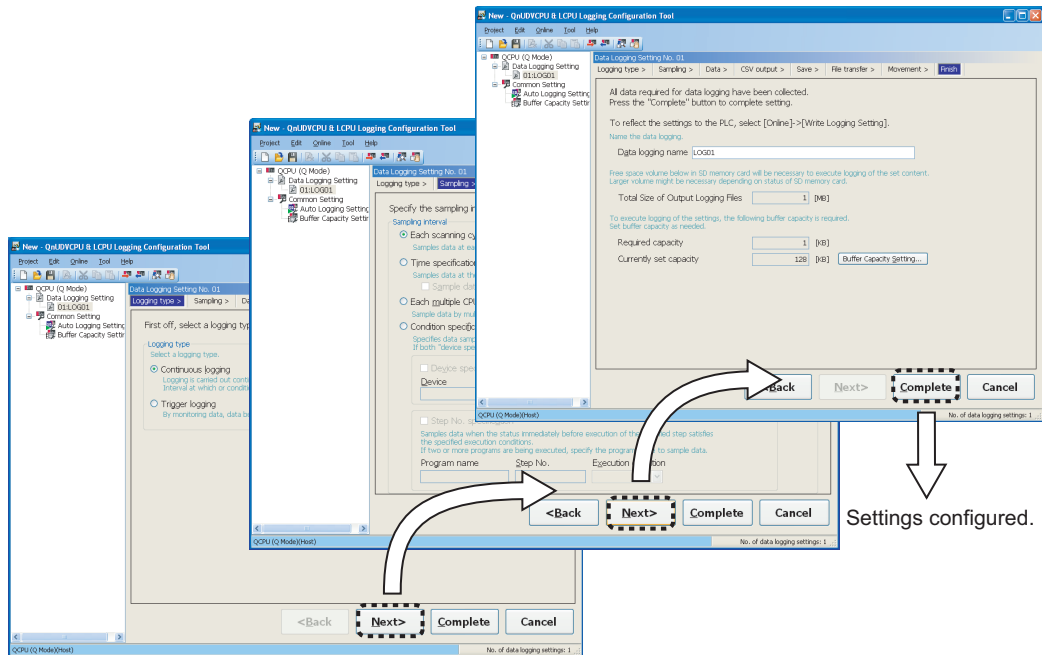

(6) A large volume of logging files can be stored.

Use of an SD memory card of up to 16GB enables a long-term logging.

(7) Data sampling for troubleshooting can be instructed easily.

Data required for troubleshooting can be collected by simply sending an SD memory card (where auto logging setting data are stored) to the factory floor and inserting it into the slot of the CPU module. (Auto logging function) Furthermore, the logged data can be analyzed if the SD memory card is returned to the office after termination of the logging.

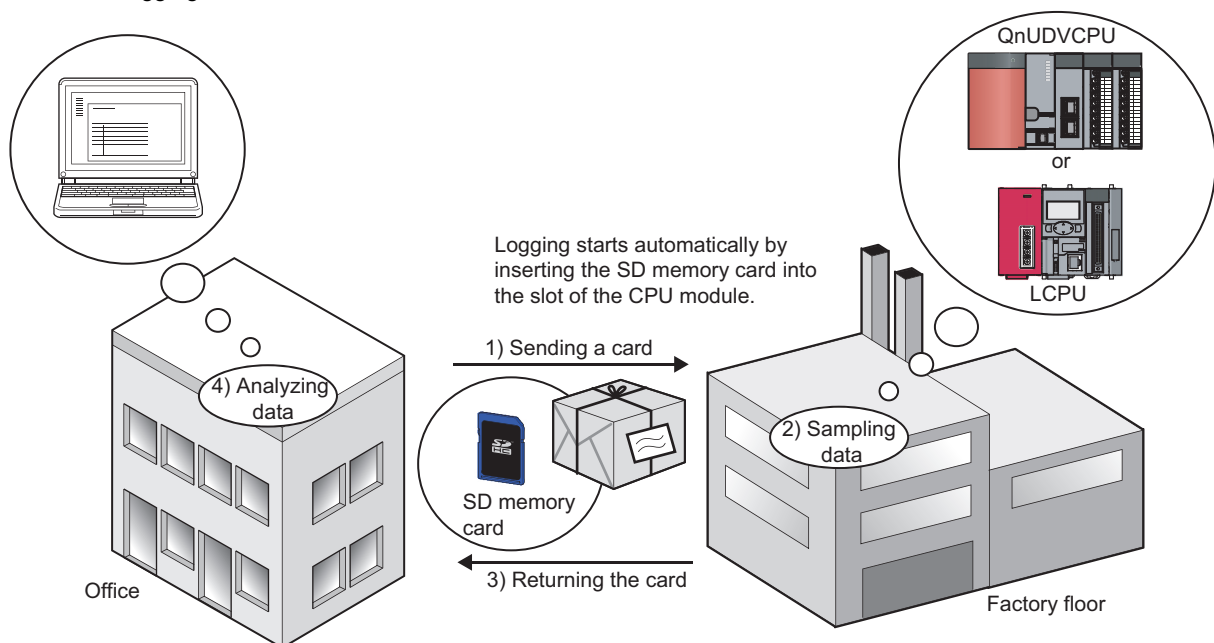

(8) Data logging files can be transferred from the CPU module to the FTP server

By using the data logging file transfer function, the CPU module serves as an FTP client, and data logging files in SD memory cards can be transferred to the FTP server. (Page 82, Section 7.4) Since data logging files can be managed by one FTP server, data management and maintenance work can be reduced.

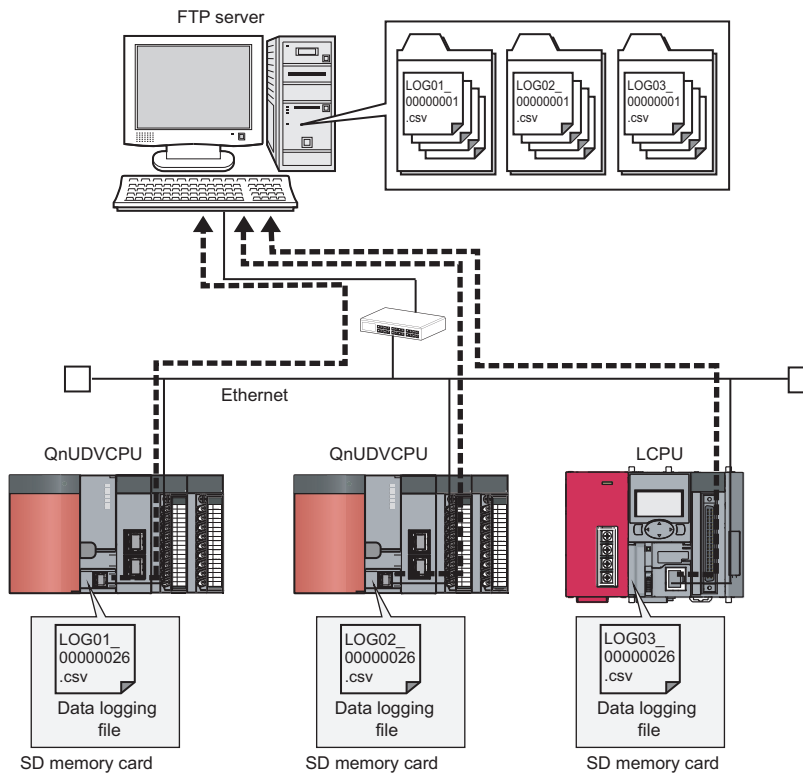

Point

The data logging file transfer function requires an FTP server. For details on the server, refer to the manual for the server used.

1.2 Processing Outline

Device values collected from the CPU module are stored in the data logging file in an SD memory card. All of the data collected over the specified period can be stored, and these data can be analyzed in detail.

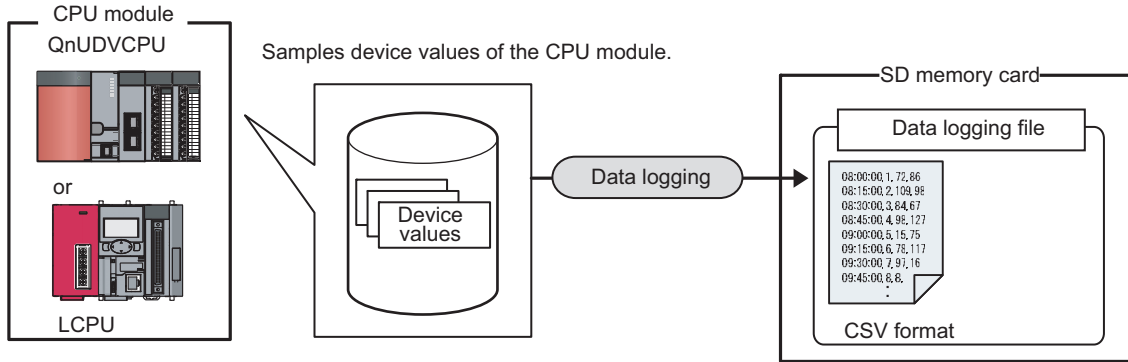

CHAPTER 2 SYSTEM CONFIGURATION

This chapter describes a system configuration for executing the data logging function.

2.1 Overall System Configuration

An overall system configuration for executing the data logging function is shown below.

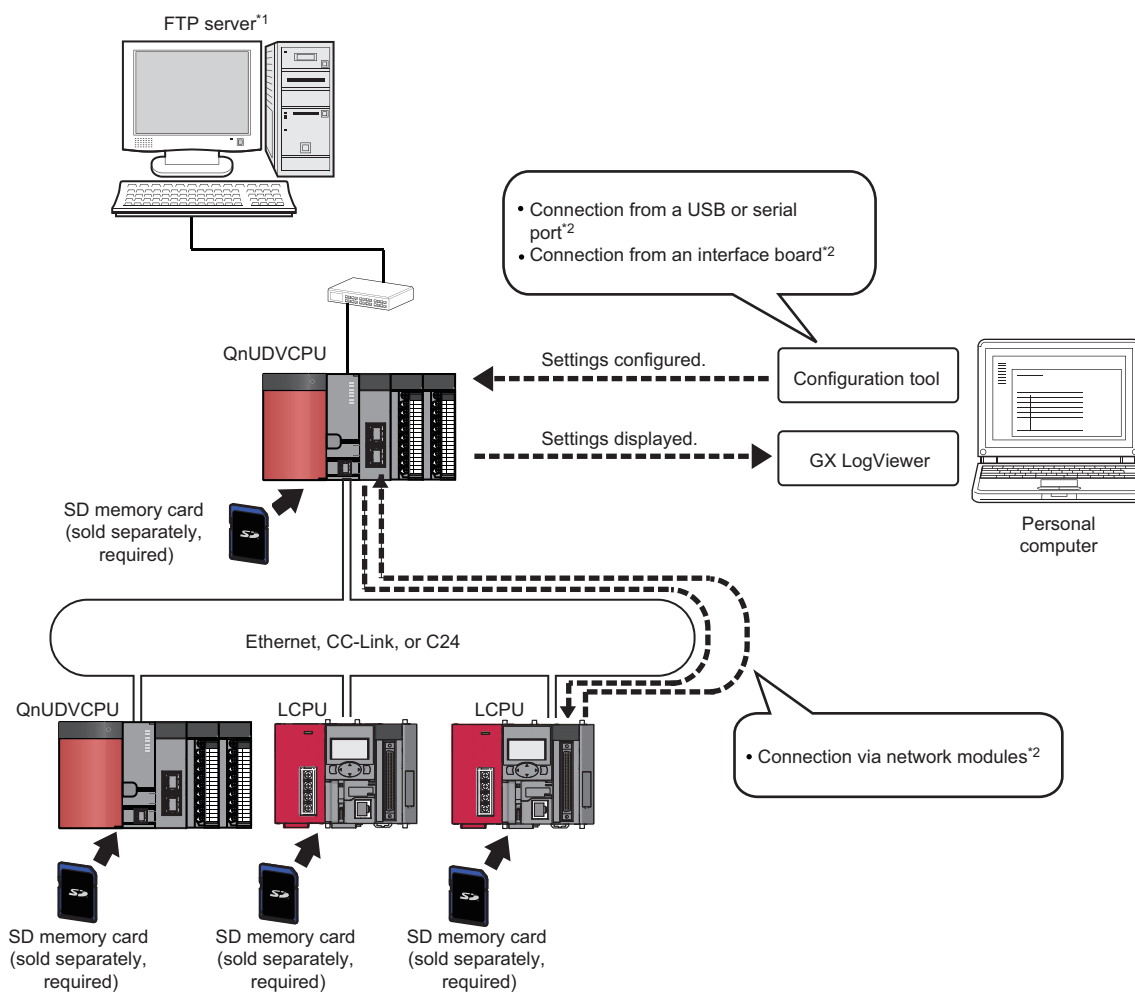

*1 The data logging file transfer function requires an FTP server. For details on the server, refer to the manual for the server used.

*2 For connection, refer to Page 28, Section 2.1.2 and Page 31, Section 2.1.3.

Point



For connection to the CPU module, refer to Page 32, Section 2.2.

2.1.1 Software

The following software can be used for data logging. For information on how to get and start it, refer to  Page 46, CHAPTER 5.

Name	Description
CPU Module Logging Configuration Tool	Software to configure data logging settings and to manage collected data
GX LogViewer	Software to display data collected by data logging

Point

- Some project files created or data logging settings configured by a new version of the configuration tool may not be read by the older version. Use the latest version of the configuration tool. ( Page 46, Section 5.1)
- GX LogViewer is not an indispensable tool for executing the data logging function. Use it for graphical display of logged data. This manual does not contain descriptions of GX LogViewer, unless otherwise required. For details on GX LogViewer, refer to the following.
 -  GX LogViewer Version 1 Operating Manual

2.1.2 Connection from a USB or serial port

The figure below shows configurations of the systems that are connectable through the USB or serial port of a personal computer.

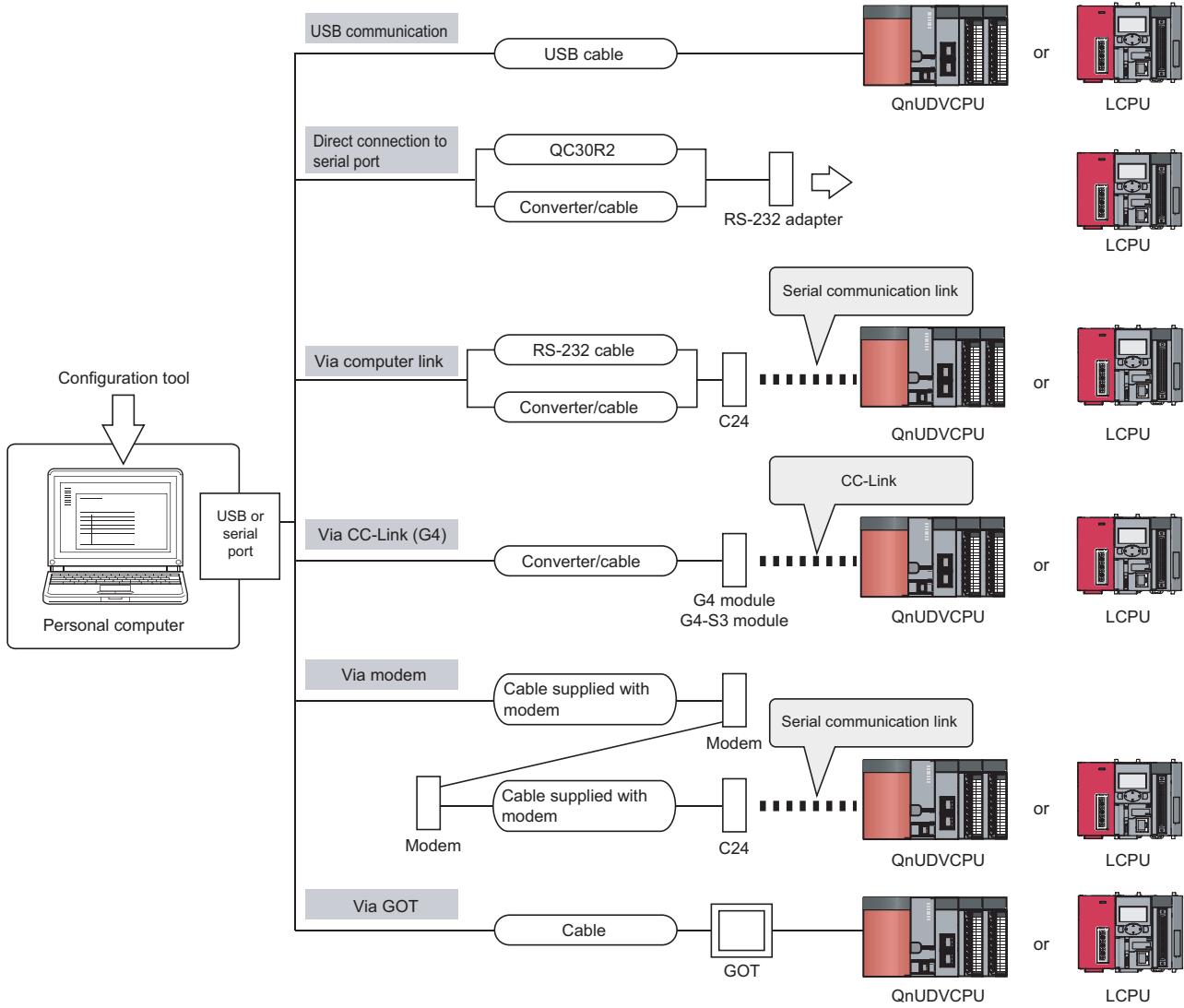

(1) Using a USB cable

The following USB cable and adapter can be used.

- USB cable (USB A type — USB miniB type)
- USB adapter (USB B type — USB miniB type)

Point

Install a USB driver when using a USB cable for the first time. (☞ Installing a USB Driver)

Only one CPU module can be connected at the same time. The following configurations are not available.

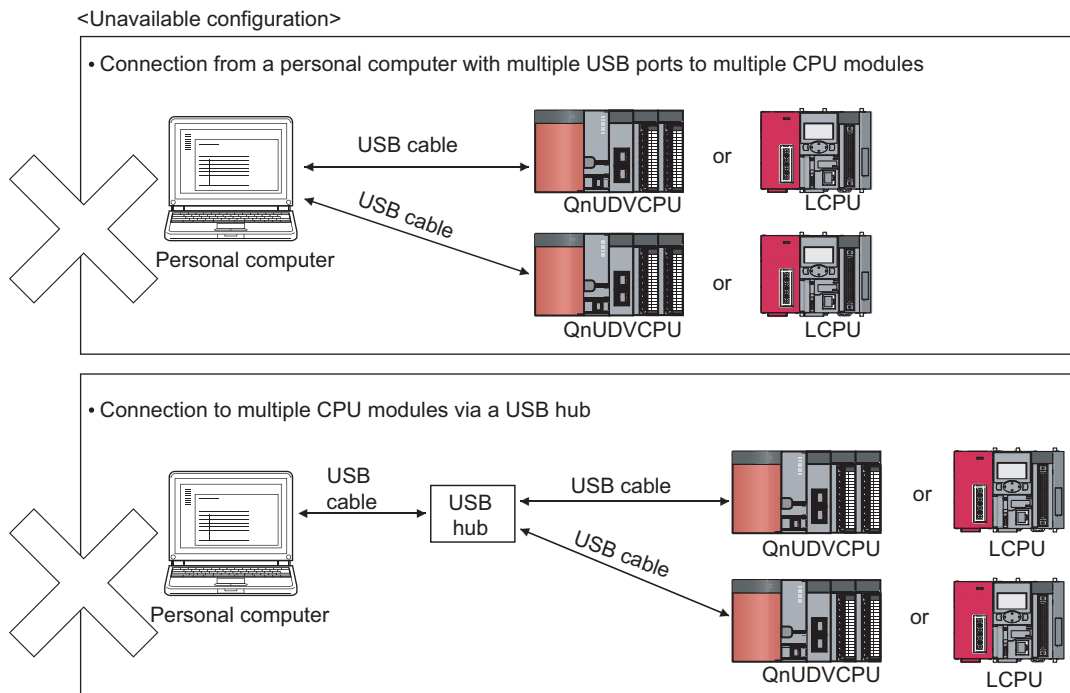

Point

When connecting a personal computer to the CPU module with a USB/RS-232 conversion cable, confirm the COM port number. For the confirmation method, refer to ☞ the manual for the cable.

(2) Using an RS-232 cable

The following RS-232 cable has been tested for operation.

Model	Manufacturer
QC30R2 (for D-sub 9-pin connector on personal computer) 	Mitsubishi Electric Corporation

Point

For high-speed communication (transmission speed: 115.2/57.6kbps), use a personal computer that supports high-speed communication. If a communication error has occurred, lower the transmission speed setting and retry the communication.

(3) Access through a GOT

The transparent function of a GOT allows an access to the CPU module through the GOT. For details, refer to the following.

 GOT1000 Series Connection Manual (Mitsubishi Products) for GT Works3

 GOT2000 Series Connection Manual (Mitsubishi Products) For GT Works3 Version1

2.1.3 Connection from an interface board

The following figure shows configurations of the systems, in each of which the personal computer is connected to a CPU module using an interface board installed in the personal computer. For the applicable interface boards and details of a USB driver, refer to the manual for the interface board used.

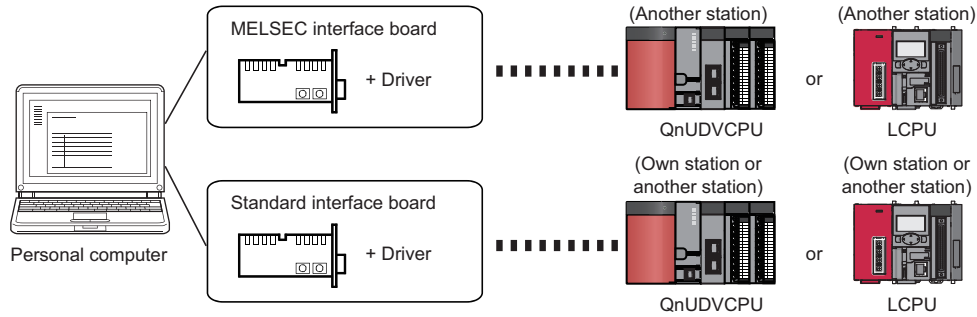

Interface board name	
MELSEC interface board	MELSECNET/H interface board
	CC-Link IE Controller Network interface board
	CC-Link IE Field Network interface board
	CC-Link Ver.1 interface board
	CC-Link Ver.2 interface board
Standard interface board	Ethernet interface board

For the connectable CPU modules, refer to the manual for the interface board used.

Point

TCP connection is recommended when devices are connected on Ethernet. For Ethernet direct connection or UDP connection, it takes time to process the following:

- Opening the window of the configuration tool
- Logging file operation (📄 Page 152, Section 8.11)

For specifications of Ethernet communication, refer to the following.

- 📖 QnUCPU User's Manual (Communication via Built-in Ethernet Port)
- 📖 MELSEC-L CPU Module User's Manual (Built-In Ethernet Function)

2.2 Precautions for Ethernet Connection

This section describes precautions for connecting a personal computer to the CPU module over Ethernet.

(1) When the Windows Firewall setting is enabled

Disable the Windows Firewall setting.

(2) When multiple IP addresses are valid at the same time

Do not select direct connection setting when two or more IP addresses are valid at the same time as follows:

- To multiple Ethernet ports (network devices) of a personal computer, multiple IP addresses are assigned.
- Wireless LAN setting is enabled, in addition to the Ethernet port setting of the personal computer.
- To one Ethernet port of the personal computer, more than one IP address are assigned.

2.3 Operating Environment for the Configuration Tool

For the operating environment of the configuration tool, refer to the following files included in the installers:

 CPU Module Logging Configuration Tool/GX LogViewer Installation Instructions (BCN-P5999-0506)

CHAPTER 3 SPECIFICATIONS

This chapter describes the specifications of the data logging function.

3.1 Function Specifications

The following lists the specifications of the data logging function.

Item		Specifications	Reference	
Number of data logging settings		10		
Data storage location		Standard ROM (configuration files only), SD memory card	Page 48, CHAPTER 6	
Logging type		<ul style="list-style-type: none"> • Continuous logging • Trigger logging • Specification period logging^{*4} 	Page 56, Section 6.3	
Data sampling	Sampling interval	<ul style="list-style-type: none"> • Each scanning cycle • Time specification • Each multiple CPU high speed transmission cycle^{*2} • Condition specification (Device specification, Step No. specification) 	Page 50, Section 6.2	
	Number of data sampling points	Up to 1280 (128 points per setting)		
	AND conjunction	In the Sampling interval setting, Device and Step No. under "Condition specification" can be specified in combination (AND conjunction).		
Data processing	Trigger logging	Trigger condition	<ul style="list-style-type: none"> • Condition specification (Device change specification, Step No. specification) • When trigger instruction executed • When data logging trigger activated 	Page 57, Section 6.3.2, Page 59, Section 6.3.2 (1)
		AND conjunction	In the Trigger setting, Device data change and Step No. under "Condition specification" can be specified in combination (AND conjunction).	
		Trigger logging range	Data of the specified number of records are logged before and after a trigger.	
		Number of triggers	1	
		Number of trigger logging records	Up to 1000000	
File output	File name		Additional information ^{*3} + File number (serial number)	Page 37, Section 3.3
	File format		CSV file	
	Data type		<ul style="list-style-type: none"> • Bit • Word (unsigned) • Word (signed) • Double word (unsigned) • Double word (signed) • Single-precision real number • Double-precision real number • Character string: 1 to 256 characters • Numeric string: 1 to 256 bytes 	
	Data output format (CSV file)		<ul style="list-style-type: none"> • Decimal format • Hexadecimal format • Exponential format 	
Handling of output files	File switching	File switching timing	<ul style="list-style-type: none"> • No. of records • File size 	Page 64, Section 6.5
		Number of saved files	1 to 65535	

Item		Specifications	Reference
Others	Data logging operation at transition to RUN	Specify the operation at the time of status change, from power on to RUN, from reset to RUN, or from STOP to RUN, after registration of the data logging setting.	Page 77, Section 7.1
	Auto logging by inserting an SD memory card	By inserting an SD memory card (to which data logging settings have been written), data logging automatically starts.	Page 78, Section 7.2
	File access	The FTP server function allows saving and deletion of data logging files from the SD memory card installed in the CPU module to the personal computer.	Page 81, Section 7.3
	Data logging file transfer function*1	Data logging files can be transferred from the CPU module to the FTP server on LAN.	Page 82, Section 7.4

*1 Before using the data logging file transfer function with the LCPU, check the versions of the CPU module and configuration tool used. (☞ Page 190, Appendix 2)

*2 The setting is available only for the High-speed Universal model QCPU and the Universal model Process CPU.

*3 For additional information, refer to ☞ Page 127, Section 8.4.12.

*4 The function is available only for the High-speed Universal model QCPU and the Universal model Process CPU. Before using this function, check the versions of the CPU module and configuration tool used. (☞ Page 190, Appendix 2)

3.2 Folder Structure

The following is the folder structure of an SD memory card that is installed in the CPU module. When an access is made by the FTP function, "/" denotes that it is the root folder (directory) of the SD memory card.

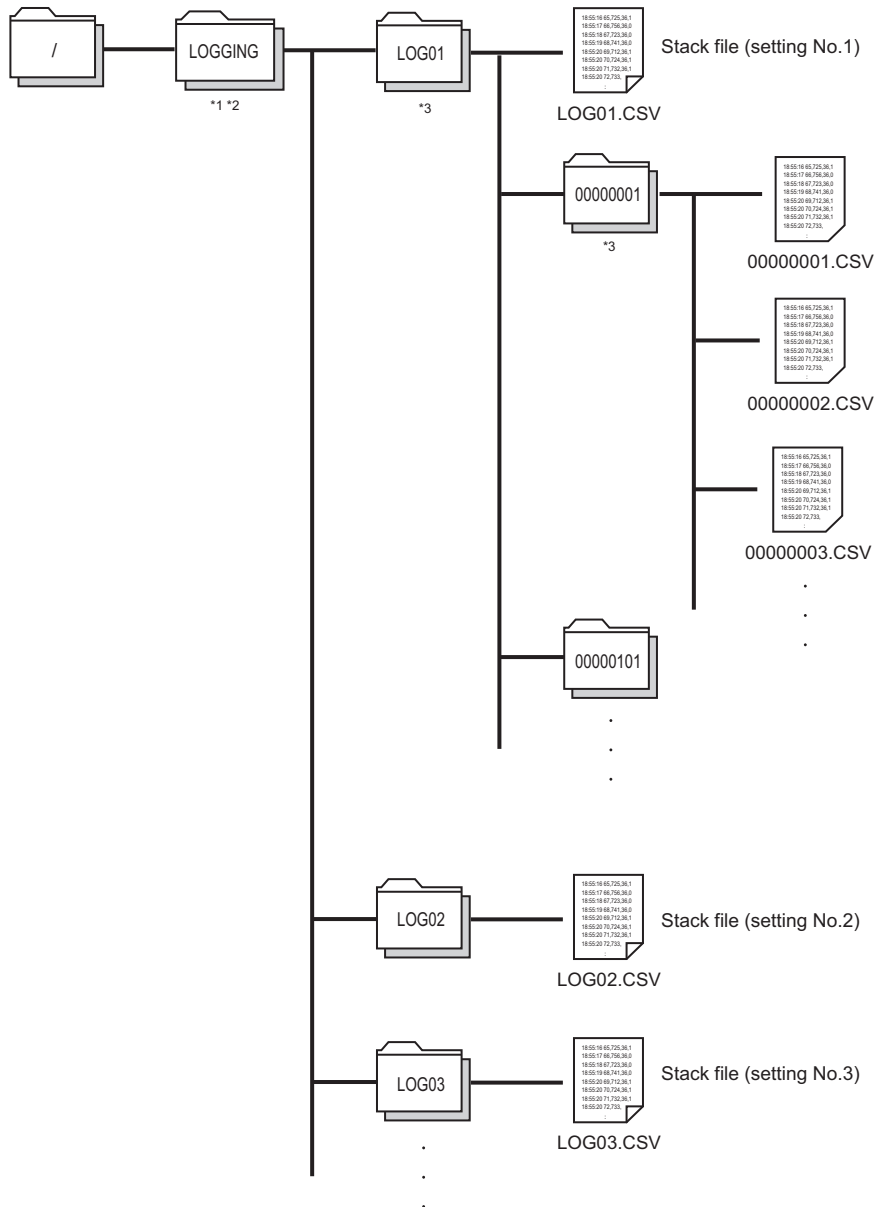

- *1 The folder name is fixed.
- *2 Do not create any file or folder under the LOGGING folder using a personal computer.
- *3 Delete unnecessary folders by:
 - Using a personal computer
 - Logging file operation ( Page 152, Section 8.11)

3.3 CSV File Output Format

This section describes the CSV format specifications and lines and columns output.

3.3.1 CSV format specifications

The CSV file format is specified as shown below.

Item	Description
Delimiter	Comma (,)
Line feed code	CRLF (0x0D, 0x0A)
Character code	ASCII or Shift JIS
Field data	Double quotation marks (" ") and commas (,) must not be included in each of data.*1

- *1 When "Output device comments for data column" is selected in "CSV output" of the data logging setting, if a double quotation mark (" ") or comma (,) is included in a device comment, the data must be as follows:
- The entire data must be enclosed with double quotation marks (" ").
 - Embedded double quotation marks (" ") must be doubled.

3.3.2 Output details of lines and columns

An example of the lines and columns output is shown below.

File information line	[LOGGING]	L1	3	4	5	2				
Comment line	LOGGING TEST									
Data type information line	DATETIME[YYYY/MM/DD hh.mm.ss.s]	INTERVAL	STEP NO.	PROGRAM NAME	INDEX	BIT[1;0]	LONG[DEC.0]	USHORT[HEX]	TRIGGER[*]	
Data name line	TIME	INTERVAL[μs]	STEP NO.	PROGRAM NAME	INDEX	M0	D100	W30	Trigger	
Data line	2009/10/01 12:00:00,000	0	10	MAIN	1	1	1234	FFFF		
	2009/10/01 12:01:00,000	60000000	2	MAIN1	2	0	1234		1	
	2009/10/01 12:02:00,000	60000000	15	MAIN1	3	0	0	FFFF		
	2009/10/01 12:03:00,000	60000000	100	MAIN2	4	0	0		1	
	2009/10/01 12:04:00,000	60000000	100	MAIN2	5	0	12345678	FFFF		
	2009/10/01 12:05:00,000	60000000	1	MAIN	6	0	12345678		1*	
	2009/10/01 12:06:00,000	60000000	0	MAIN	7	0	12345679	FFFF		
2009/10/01 12:07:00,000	60000000	0	MAIN	8	0	12345680		1		

3.3 CSV File Output Format
3.3.1 CSV Format specifications

Output of the following information can be disabled. (☞ Page 125, Section 8.4.11)

- Date and time column
- Trigger information column (selectable only for trigger logging)
- Index column
- Data sampling interval column
- Execution program name column
- Execution step No. column
- Comment line

(1) File information line

Information on the file is displayed.

Item	Description	Size*1
File type	[LOGGING] is output.	9 bytes
File version	File version (fixed to Q1 for High-speed Universal model QCPU and Universal model Process CPU, or fixed to L1 for LCPU)	2 bytes
Data type information line number	Line number indicating the Data type information line is entered.	1 byte
Data name line number	Line number indicating the Data name line is entered.	1 byte
Data start line number	Line number indicating the first of the data lines is entered.	1 byte
Comment line number	Line number indicating the Comment line is entered. If the Comment line data are not to be output, this field is left blank.	0 to 1 byte

*1 The size of the File information line is the total of the following. (When outputting a comment)
 9 (File type) + 2 (File version) + 1 (Data type information line number) + 1 (Line No. of Data name line number) + 1 (Data start line number) + 1 (Comment line number) + 5 (number of commas) + 2 (CR + LF) = 22 bytes

(2) Comment line

A comment is displayed.

Item	Description	Size*1
Comment	A comment set in the configuration tool is output. (Up to 512 one-byte or 256 two-byte characters can be output. If there is no setting, blank space is output.)	0 to 512 bytes

*1 The size of the Comment line is the total of the following.
 The size of the characters used for the comment (1 byte for each one-byte character, 2 bytes for each two-byte character) + 2 (CR + LF)

(3) Data type information line

The data type of each column is displayed. Data are output in the format of (data type) [(additional information)].

Item	"Data type" output	Size*1	"Additional information" output	Size*1
Date and time column	DATETIME	8 bytes	A format is output. Example: [YYYY/MM/DD hh:mm:ss.s]	3 to 34 bytes
Data sampling interval column	INTERVAL	8 bytes	None	0 bytes
Execution step No.	STEP NO.	8 bytes		0 bytes
Execution program name column	PROGRAM NAME	12 bytes		0 bytes
Index column	INDEX	5 bytes		0 bytes
Data column	Bit type: BIT	3 bytes	Bit type: [1:0]	5 bytes
	16-bit integer (unsigned): USHORT	5 bytes	Decimal format: [DEC.0]	7 bytes
	16-bit integer (signed): SHORT	6 bytes		
	32-bit integer (unsigned): ULONG	4 bytes	Hexadecimal format: [HEX]	5 bytes
	32-bit integer (signed): LONG	5 bytes		
	Single-precision floating point (32-bit): FLOAT	5 bytes	Exponential representation: [EXP, (number of fractional digits)]	7 to 8 bytes
	Double-precision floating point (64-bit): DOUBLE	6 bytes		
	Character string type: STRING	6 bytes	Character string or numeric string type: The specified length of data (in byte units) is output.	3 to 5 bytes
Numeric string type: RAW	3 bytes			
Trigger information column	TRIGGER	7 bytes	[(Character string for indicating trigger occurrence)] is output. (Semicolon (;), double quotation marks (" ") and comma (,) cannot be used.)	3 to 34 bytes

- *1 For example, when 128 point decimal data is logged in the 16-bit integer (signed) format (when the date and time (in "YYYY/MM/DD hh:mm:ss.s" format), data sampling interval, execution step No., execution program name, and index columns are selected for output), the size of the data type information line is the total of the following.
 $(8 + 23)$ (date and time) + 8 (data sampling interval) + 8 (execution step No.) + 12 (execution program name) + 5 (index) + $(5 + 7) \times 128$ (data) + 132 (number of commas) + 2 (CR + LF) = 1734 bytes

(4) Data name line

The data name of each column is displayed.

Item	Description	Size ^{*3}
Date and time column	TIME is output.	4 bytes
Data sampling interval column	INTERVAL [us] is output.	12 bytes
Execution step No.	STEP NO. is output.	8 bytes
Execution program name column	PROGRAM NAME is output.	12 bytes
Index column	INDEX is output.	5 bytes
Data column	"Device No." or "Device comment" ^{*1*2} specified in the setting is displayed.	1 to 32 bytes
Trigger information column	Trigger is output.	7 bytes

*1 The device comment of the comment file specified in the setting is displayed.

*2 Even if "Output device comments for data column" is selected, device No. is displayed when:

- No device comment is set.
- The specified device comment file does not exist.
- A digit-specified bit device is specified for sampling data.
- A bit-specified word device is specified for sampling data.

*3 For example, when 128 point data in D100 to D227 is logged (when the date and time, data sampling interval, execution step No., execution program name, and index columns are selected for output, and when device No. is selected for the data column), the size of the data name line is the total of the following.

4 (date and time) + 12 (data sampling interval) + 8 (execution step No.) + 12 (execution program name) + 5 (index) + (4 × 128) (data) + 132 (number of commas) + 2 (CR + LF) = 687 bytes

(5) Data line

Sampled data values are displayed. One line contains the data sampled at one time.

Item	Description	Size ^{*11}
Date and time column	Date and time information is output. ^{*12}	1 to 32 bytes
Data sampling interval column	A time interval between the previous and current sampling events is output. ^{*1} (Unit: μ s, Range: 1 to 100000000000) ^{*2}	1 to 12 bytes
Execution step No.	An execution step No. is output. ^{*6,7}	1 to 6 bytes
Execution program name column	An execution program name is output. ^{*8,9}	1 to 8 bytes
Index column	An index No. of the data sampled in data logging is output. ^{*3} (Range: 1 to 4294967295) ^{*4}	1 to 10 bytes
Data column	When bit is specified: Bit ON = 1, or bit OFF = 0 is output.	1 byte
	When unsigned word or double-word type is specified: Data are output in the format specified among decimal, hexadecimal, and exponential formats.	Decimal format: 1 to 6 bytes Hexadecimal format: 1 to 4 bytes Exponential format: 5 to 21 bytes
	When signed word or double-word type is specified: Data are output in the format specified among decimal, hexadecimal, and exponential formats.	Decimal format: 1 to 11 bytes Hexadecimal format: 1 to 8 bytes Exponential format: 5 to 22 bytes
	When single- or double-precision real number is specified: Data are output in the specified decimal ^{*10} or exponential format. When the specified data type is not applicable to the data, "NaN" is output in the data line. For the value range applicable to each real number type, refer to  Page 42, Section 3.3.3.	
	When character string type is specified: A string of characters in the specified size is output. If "0" is included in the data, the data after the "0" is not output because it indicates the end of the string. ^{*5}	1 to 256 bytes
	When numeric string type is specified: Data are converted into hexadecimal characters in byte units, and output without any space.	2 to 512 bytes
Trigger information column	The line, where a trigger has occurred, is output.	0 to 32 bytes

*1 At the first sampling, "0" is stored.

*2 When the upper limit of the display range is exceeded, the value returns to 1, and the time interval measured again is output.

*3 If any data are missed to be sampled, the index value is reset to 1.

*4 When the maximum value is exceeded, it returns to 1 and is incremented again.

*5 Characters other than ASCII and Shift-JIS code characters, double quotation marks (" "), commas (,), and semicolons (;) are replaced with periods (.).

*6 If the timing of sampling coincides with a system operation (such as a system interrupt), "0" is output.

*7 When "Each scanning cycle" is set to "Sampling", the step No. of the END instruction in the last program executed is output.

*8 If the timing of sampling coincides with a system operation (such as a system interrupt), "**SYSTEM" is output.

*9 When "Each scanning cycle" is set to "Sampling", the name of the last program executed is output.

*10 When the value to be output is outside the range of -2147483648.0 to 4294967295.0, it is displayed in the format equivalent to "exponential representation and 9 fractional digits".

*11 For example, when 128 point data in D100 to D227 is logged in the unsigned word type format (when the date and time (in "YYYY/MM/DD hh:mm:ss.s" format), data sampling interval, execution step No, execution program name, and index columns are selected for output), the size of the data line is the total of the following.

21 (date and time) + 12 (data sampling interval) + 6 (execution step No.) + 8 (execution program name) + 10 (index) + (6 \times 128) (data) + 132 (number of commas) + 2 (CR + LF) = 959 bytes

*12 When a CSV file is opened in Excel, the date and time column is displayed in the default format of Excel. Format the cells if needed. For example, to display information of year, month, day, time, minute, second, and millisecond, specify the following user defined display format.

yyyy/mm/dd hh:mm:ss.000

3.3.3 Value ranges by output format

This section describes the value ranges available for each output format.

(1) Integer type

The value range available for each integer type is shown below.

Output format	Lower limit	Upper limit
Word (unsigned)	0	65535
Word (signed)	-32768	32767
Double word (unsigned)	0	4294967295
Double word (signed)	-2147483648	2147483647

(2) Real number type

The value range available for each real number type is shown below.

Output format	Negative value		Positive value	
	Lower limit	Upper limit	Lower limit	Upper limit
Single-precision real number	-3.4028235E+38	-1.401298E-45	1.401298E-45	3.4028235E+38
Double-precision real number	-1.79769313486231570E+308	-4.94065645841246544E-324	4.94065645841246544E-324	1.79769313486231570E+308

Point

If the output value is out of the range specified above, the following value is output.

- +Inf: when the value exceeds the upper limit of positive values
- -Inf: when the value falls below the lower limit of negative values
- 0: when the value is between the upper limit of negative values and the lower limit of positive values

Output format	-Inf	0	+Inf
Single-precision real number	0xff800000	0x00000000	0x7f800000
Double-precision real number	0xfff0000000000000	0x0000000000000000	0x7ff0000000000000

3.4 Size of Data Logging Setting File

The size of a data logging setting file is the total of the following:

- Size of a common setting data file
- Size of individual setting data files of setting No.1 to setting No.10

(1) Size of a common setting data file

The size is the total of the following:

Item	Size (byte)	Quantity
Common header	64	1
File information	4	1
Data logging common setting area	28	1

(2) Size of individual setting data files

The size is the total of the following:

Item	Size (byte)	Quantity	
Common header	64	1	
File information	4	1	
Data logging common setting area	36	1	
Sampling information	114	1	
Trigger condition setting/specification period condition setting information	122	1	
Output setting information	772	1	
Storage setting information	46	1	
Data logging sampling data area (information)	4	1	
Data logging sampling data area (number of points)	10	Total number of data points	
Data logging sampling data area (setting)	8	Number of set data	
Optional information	2	1	
	—	Total of the following:*1	
	Extension function bit	2	
	Extension function setting 1 (data logging file transfer function) setting data size	2	
Extension function setting	—	Total of the following setting 1 items:	
	Common area (size fixed)	14	
	Extension function setting 1 (data logging file transfer function) setting contents	FTP server (IP address)	7 to 15*2
		Login user name	1 to 32*2
		Login password	0 to 32*2
		Directory path	1 to 64*2

*1 When the extension function setting is the default, the size is 0 bytes.

*2 The size (byte) is the number of characters of each item.

CHAPTER 4 PROCEDURES AND SETTINGS BEFORE SYSTEM OPERATION

The following flowchart shows the steps to be performed before data logging operation.

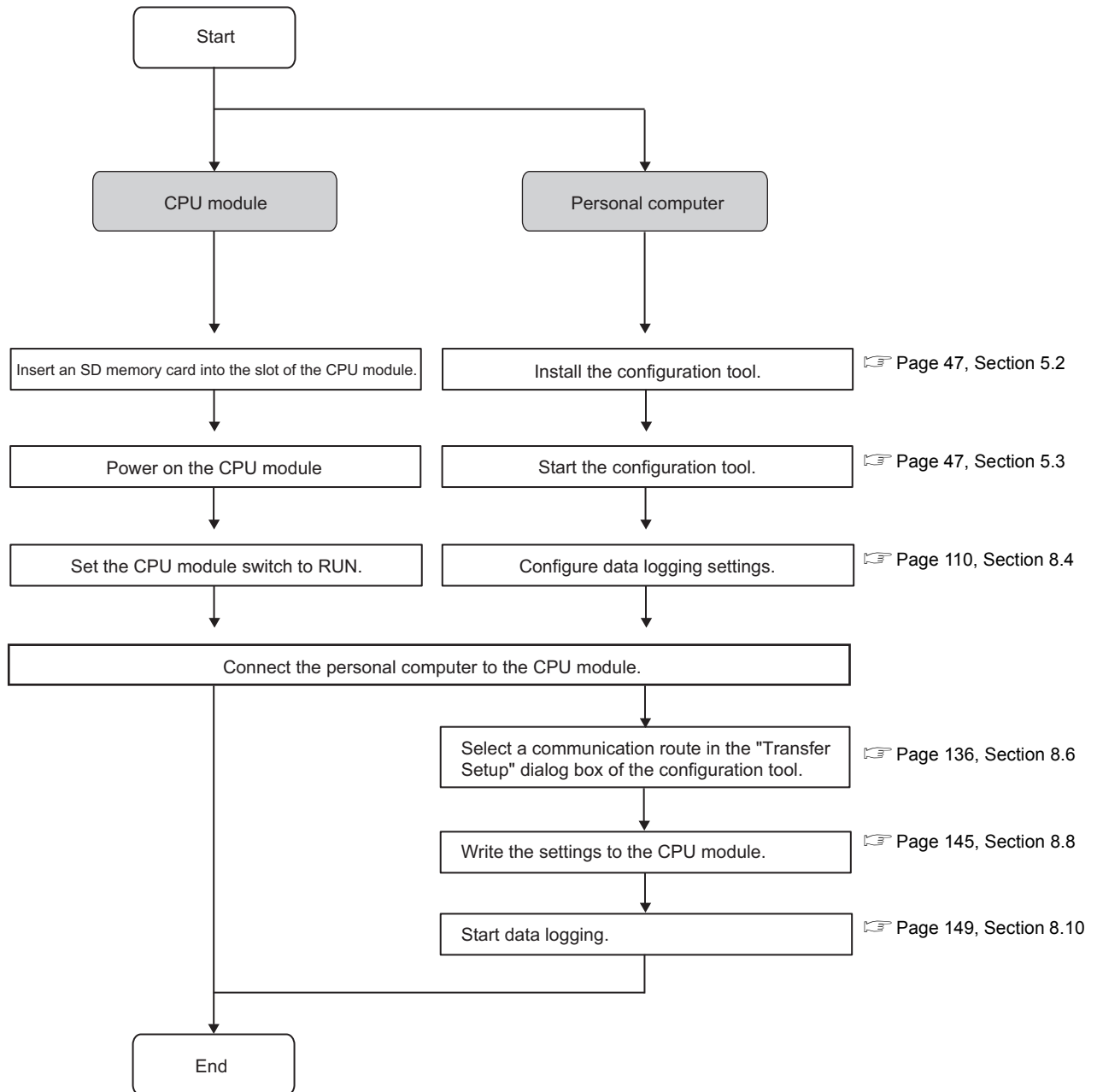

Point

For installation of the CPU module, power supply module, and SD memory card, and the installation environment, refer to the following.

[User's Manual \(Hardware Design, Maintenance and Inspection\)](#) for the CPU module used

Memo

CHAPTER 5 START-UP OF THE CONFIGURATION TOOL

This chapter describes the procedure for starting the configuration tool.

5.1 Getting the Configuration Tool

The configuration tool is included in the programming tool.

(1) Programming tools that include the configuration tool

The configuration tool is included in the CD-ROM of the following programming tools. Applicable versions are as follows:

Relevant CPU module	configuration tool	
	GX Works2	GX Developer
High-speed Universal model QCPU*1	1.98C or later	Not supported
Universal model Process CPU*1	1.492N or later	Not supported
LCPU	1.20W or later	8.89T or later

*1 For the configuration tool version, which is compatible with the High-speed Universal model QCPU and Universal model Process CPU, refer to  Page 190, Appendix 2.

5.2 Installing/Uninstalling the Configuration Tool

For the installation/uninstallation procedures, refer to the following manual included in the installer.

 CPU Module Logging Configuration Tool/GX LogViewer Installation Instructions (BCN-P5999-0506)

5.3 Starting the Configuration Tool

There are three ways to start the configuration tool:

- From the Start menu
- From the programming tool
- From GX LogViewer

(1) Start from the Start menu

After installing the configuration tool, follow the procedure below.

 [Start] ⇒ [All programs] ⇒ [MELSOFT Application] ⇒ [Logging] ⇒ [CPU Module Logging Configuration Tool]

(2) Start from the programming tool

After starting the programming tool, follow the procedure below.

 [Tool] ⇒ [Logging Configuration Tool]

(3) Start from GX LogViewer

Refer to the following.

 GX LogViewer Version 1 Operating Manual

5.4 Switching a Display Language

The configuration tool supports multiple display languages so that the display language can be changed from the menu bar on the same personal computer screen.

(1) Operating procedure

 [View] ⇒ [Switch Display Language]

(2) Precautions

If the language different from the operating system is set, the language might not be displayed properly, (e.g.: A word is cut off in the middle, or a line is cut off lengthwise.)

Remark

Before switching the display language, check the versions of the configuration tool used. ( Page 190, Appendix 2)

CHAPTER 6 DATA LOGGING FUNCTION

The data logging function allows logging of CPU module device values at the specified sampling intervals. The logged data are stored on an SD memory card.

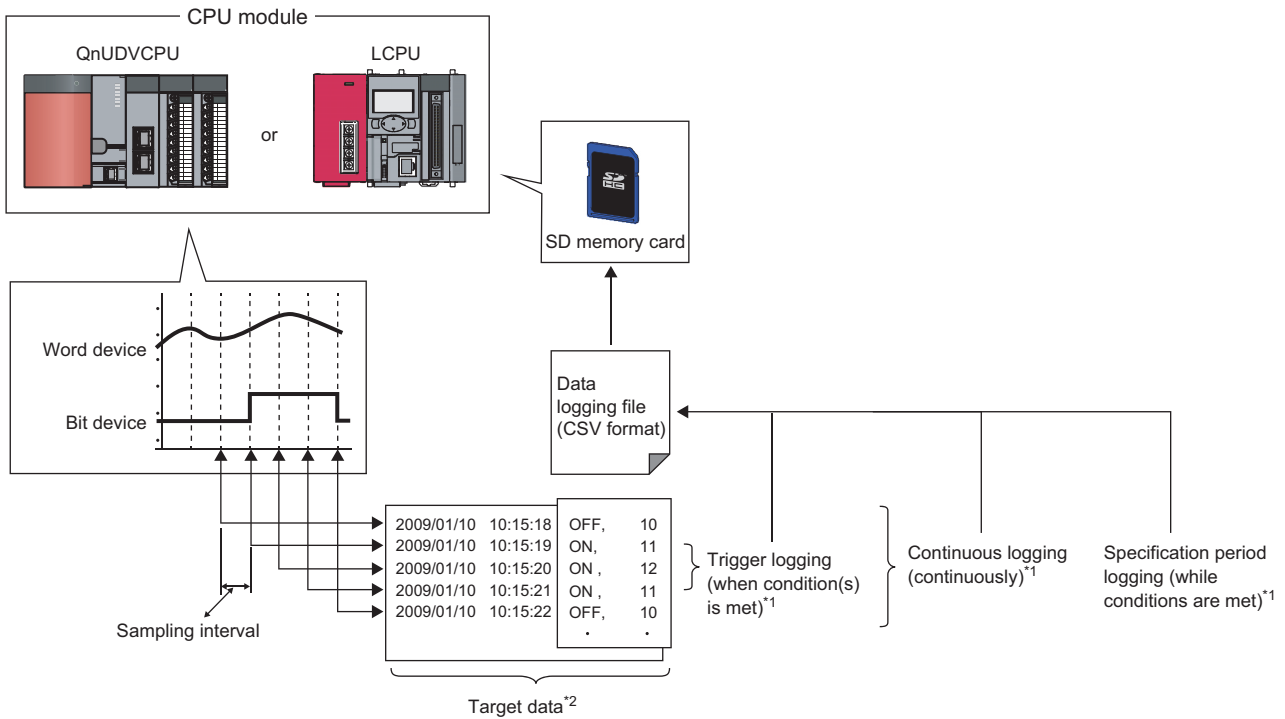

*1 For the type of logging, refer to Page 56, Section 6.3.

*2 For the target data, refer to Page 49, Section 6.1.

A block of the target data, which are collected according to the same sampling interval and logging type settings, is referred to as a data logging setting. Up to 10 data logging settings can be configured with the data logging function. (Page 110, Section 8.4)

6.1 Target Data

The target data is device memory data in the CPU module, which is saved on an SD memory card with time stamp.

(1) Data type

The following data types can be specified for data logging of the device memory.

Data type	Number of device points	Data type	Number of device points
Bit	1	Single-precision real number	2
Word (unsigned)	1	Double-precision real number	4
Double word (unsigned)	2	Character string	Specified size/2 ^{*1}
Word (signed)	1	Numeric string	Specified size/2 ^{*1}
Double word (signed)	2		

*1 The specified size ranges from 1 to 256.

Point

The number of points is calculated for each setting No. and the total number of points is used. In the following case, the total number of points is eight.

- Setting No.1 Data type (Character string), specified size (1) → 1 point
- Setting No.2 Data type (Character string), specified size (5) → 3 points
- Setting No.3 Data type (Double-precision real number) → 4 points

(2) Devices available for sampling

The following lists the devices whose data can be specified as sampling data.

Type	Description
Bit device	X (DX), Y (DY), M, L, F, SM, V, B, SB, T (contact) ^{*3} , T (coil) ^{*4} , ST (contact) ^{*3} , ST (coil) ^{*4} , C (contact) ^{*3} , C (coil) ^{*4} , FX, FY, BL□\S, J□\X ^{*5} , J□\Y ^{*5} , J□\SB ^{*5} , J□\B ^{*6}
	Bit specification of word device: D, D (extended data register), SD, W, W (extended link register), SW, R, ZR, FD, U□\G ^{*1} , J□\W ^{*5} , J□\SW ^{*5} , U3E□\G ^{*6}
Word device	T (current value), ST (current value), C (current value), D, D (extended data register), SD, W, W (extended link register), SW, R, Z, ZR, FD, U□\G ^{*1} , J□\W ^{*5} , J□\SW ^{*5} , U3E□\G ^{*6}
	Digit specification of bit device ^{*2} : X, Y, M, L, F, SM, V, B, SB, BL□\S, J□\X ^{*5} , J□\Y ^{*5} , J□\SB ^{*5} , J□\B ^{*6}

*1 The built-in I/O function does not support the U□\G specification.

*2 Digit specification of bit device is available only for K1 to K8.

*3 T (contact), ST (contact), and C (contact) are specified with TS, SS, and CS respectively.

*4 T (coil), ST (coil), and C (coil) are specified with TC, SC, and CC respectively.

*5 Before specifying the device, check the versions of the CPU module and configuration tool used. (Page 190, Appendix 2)

*6 The LCPU does not support this item.

For the above devices (except for FX, FY, FD, BL□\S, and bit specification of word device), index modification can be specified although indirect specification is not allowed.

6.2 Sampling of Target Data

Select a sampling interval and timing from the following items. (☞ Page 115, Section 8.4.4)

Setting item		Description
Each scanning cycle		Data are collected in the END processing of each scan.
Time specification	Sample data at the first END processing after the specified time has elapsed	Specify the time of sampling interval. Data are collected in the END processing after the specified time has elapsed.
	Samples data at the specified time interval.	Specify the time of sampling interval. Data are collected at the specified time intervals.
Each multiple CPU high speed transmission cycle*1		Data are collected in synchronization with the multiple CPU high speed transfer cycle in a multiple CPU system where the multiple CPU high speed transmission function is used.
Condition specification	Device specification <ul style="list-style-type: none"> • When the bit of the bit device rises • When the bit of the bit device falls • When the word device value meets the specified value • When the word device data is changed 	Data are collected when the specified device condition is met in the END processing of each scan.
	Step No. specification <ul style="list-style-type: none"> • Always • When execution condition is ON • When execution condition is OFF • When execution condition rises • When execution condition falls 	Data are collected during execution of the specified step and when the specified condition is met.

*1 The LCPU does not support this item.

(1) Each scanning cycle

Data are collected in the END processing of each scan.

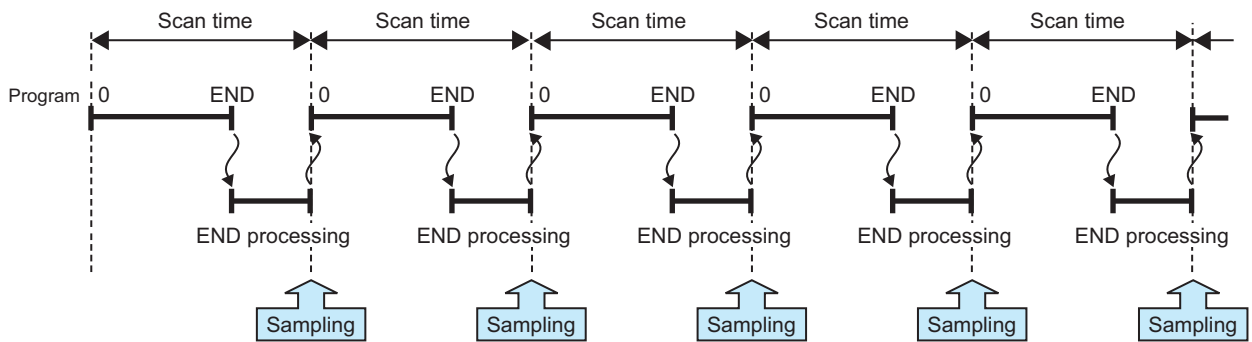

(2) Time specification*1

Data are collected at the specified time intervals. The setting range is as follows:

- Millisecond: 1 to 32767 (in increments of 1ms)
- Second: 1 to 86400 (in increments of 1s)

*1 In the following cases, scan time will be extended and a watchdog timer error will occur. Pay attention to the sampling interval and timing or the time spent for one data logging processing.

- Short sampling interval, and many data logging executions per scan
- Large volume of data to be collected, and long data logging processing time

(a) Sample data at the first END processing after the specified time has elapsed

Select this when data are to be collected at relatively long intervals and at the timing of END processing, not during any other program execution.

Ex. When 100 milliseconds are specified

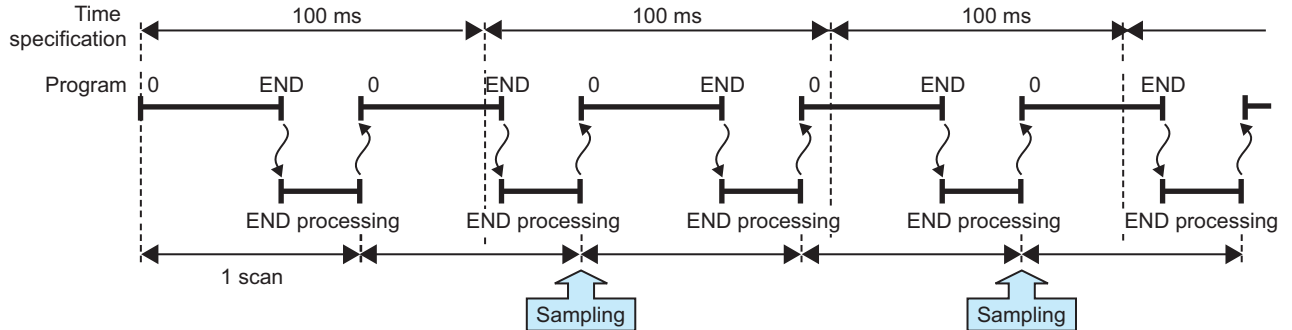

Point

Specify a time value larger than the scan time. When scan time is longer than the time specified, even if more than one sampling timing occur within one scan, only one sampling is performed in the END processing.

(b) Samples data at the specified time interval*1

Select this when data are to be collected at relatively short intervals and in real time.

Ex. When 5 milliseconds are specified

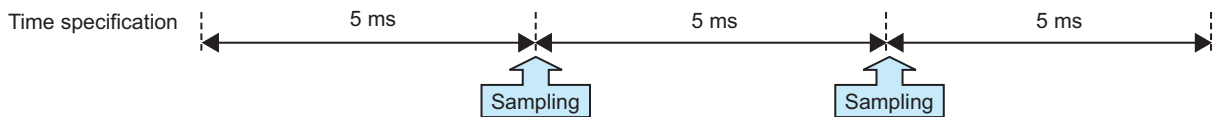

*1 Even if clock data are changed during execution of data logging, actual sampling interval will not be changed.

(3) Each multiple CPU high speed transmission cycle (High-speed Universal model QCPU and Universal model Process CPU only)

After the I45 interrupt program is executed, data are collected at the specified interval.

Ex. When the interval is set to 3

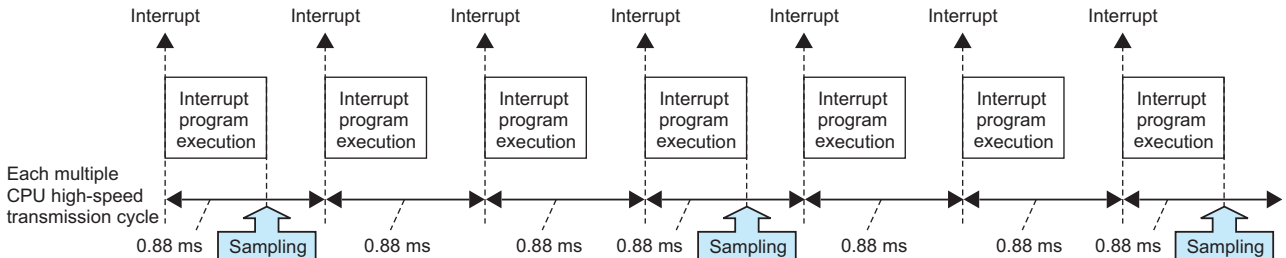

Point

Data can be collected only when the following conditions are all met.

- A multiple CPU high-speed main base unit (Q3□DB) is used.
- The system contains two or more CPU modules (multiple CPU system), and the use of the multiple CPU high-speed transmission function is enabled.
- The program includes an interrupt pointer (I45).
- The EI instruction is being executed, and the interrupt pointer (I45) is not masked.

(4) Condition specification

Data are collected when the state of the specified device or step meets the specified condition. Furthermore, if both of (a) and (b) are selected, an AND condition can be created.

(a) Device specification

Data are collected when the specified device condition is met in the END processing of each scan.

<Data are continuously collected while the condition is satisfied.>

While the condition of the specified device is met, device data are collected in the END processing of each scan. Set the following.

- When the word device value meets the specified value: When the current value of the specified device is the specified value

Ex. When the word device value meets the specified value

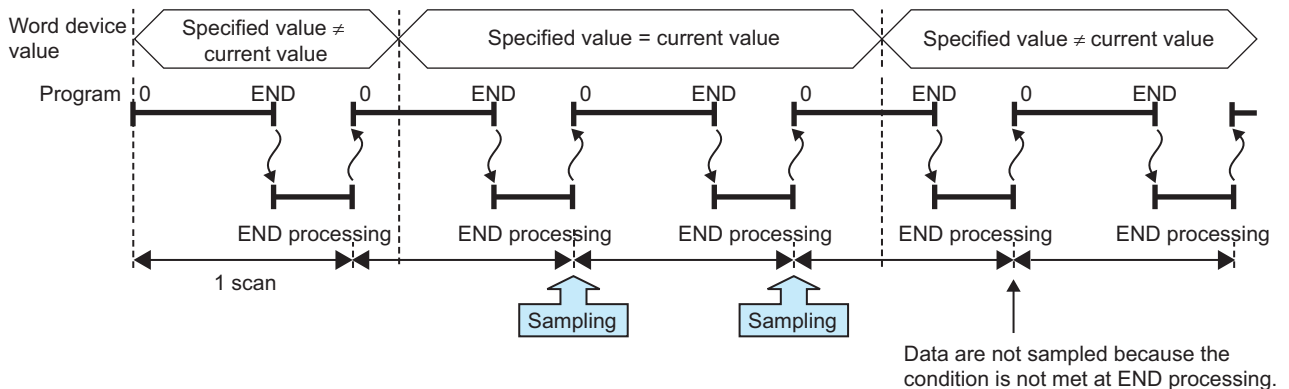

<Data are collected only when the status is changed.>

Device data are collected only in the END processing of the scan where the specified device condition is changed. Set the following.

- When the bit of the bit device rises: When the specified device is turned on
- When the bit of the bit device falls: When the specified device is turned off
- When the word device data is changed: When the current value of the specified device is changed

Ex. When the word device data is changed

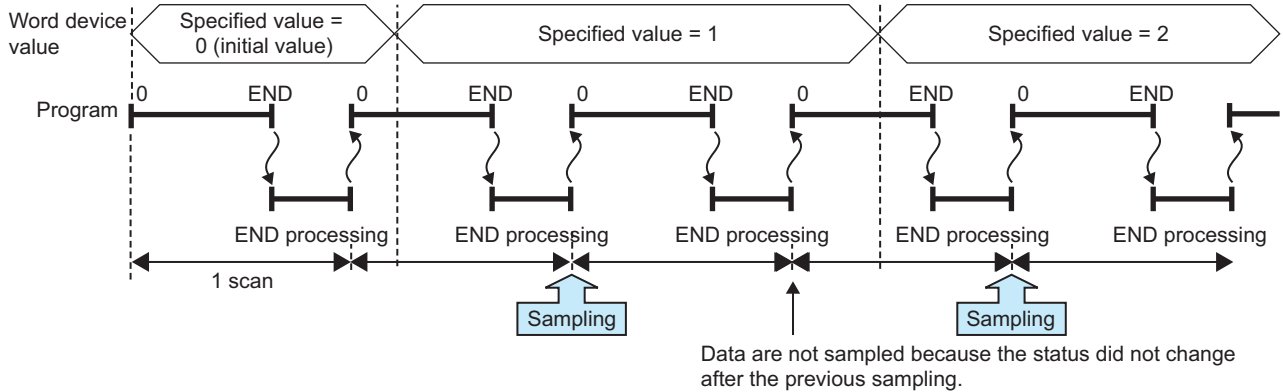

The following devices can be specified as device data conditions.

Type	Description
Bit device	X, Y, M, L, F, SM, V, B, SB, T (contact) ^{*3} , ST (contact) ^{*3} , C (contact) ^{*3} , FX, FY, BL□\S, J□\X ^{*4} , J□\Y ^{*4} , J□\SB ^{*4} , J□\B ^{*5}
	Bit specification of word device: D, D (extended data register), SD, W, W (extended link register), SW, R, ZR, FD, U□\G ^{*1} , J□\W ^{*4} , J□\SW ^{*4} , U3E□\G ^{*5}
Word device	T (current value), ST (current value), C (current value), D, D (extended data register), SD, W, W (extended link register), SW, R, Z, ZR, FD, U□\G ^{*1} , J□\W ^{*4} , J□\SW ^{*4} , J□\B ^{*5}
	Digit specification of bit device ^{*2} : X, Y, M, L, F, SM, V, B, SB, BL□\S, J□\X ^{*4} , J□\Y ^{*4} , J□\SB ^{*4} , U3E□\G ^{*5}

- *1 The built-in I/O function does not support the U□\G specification.
- *2 Digit specification of bit device is available only for K1 to K4.
- *3 T (contact), ST (contact), and C (contact) are specified with TS, SS, and CS respectively.
- *4 Before specifying the device, check the versions of the CPU module and configuration tool used. (Page 190, Appendix 2)
- *5 The LCPU does not support this item.

For the above devices, the following modification is available.

- Indirect specification
- Index modification (except for FX, FY, FD, BL□\S, and bit specification of word device)

(b) Step No. specification

Data are collected when the specified condition is met immediately before execution of the specified step. In addition to "Step No.", set "Program name" and "Execution condition".

<Data are continuously collected while the condition is satisfied.>

Select an execution condition from the following.

- Always: Any time regardless of the operation status immediately before the execution of the specified step
- When the specified condition is ON: The operation status immediately before the execution of the specified step is the Executed state.
- When the specified condition is OFF: The operation status immediately before the execution of the specified step is the Not Executed state.

Ex. When the specified condition is ON

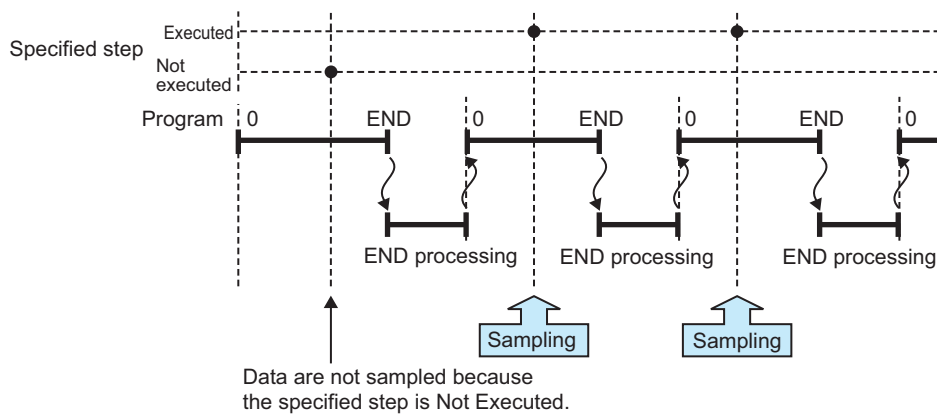

<Data are collected only when the status is changed.>

Select an execution condition from the following.

- When the specified condition rises: The operation status immediately before the execution of the specified step has changed from Not Executed to Executed.
- When the specified condition falls: The operation status immediately before the execution of the specified step has changed from Executed to Not Executed.

Ex. When the specified condition rises

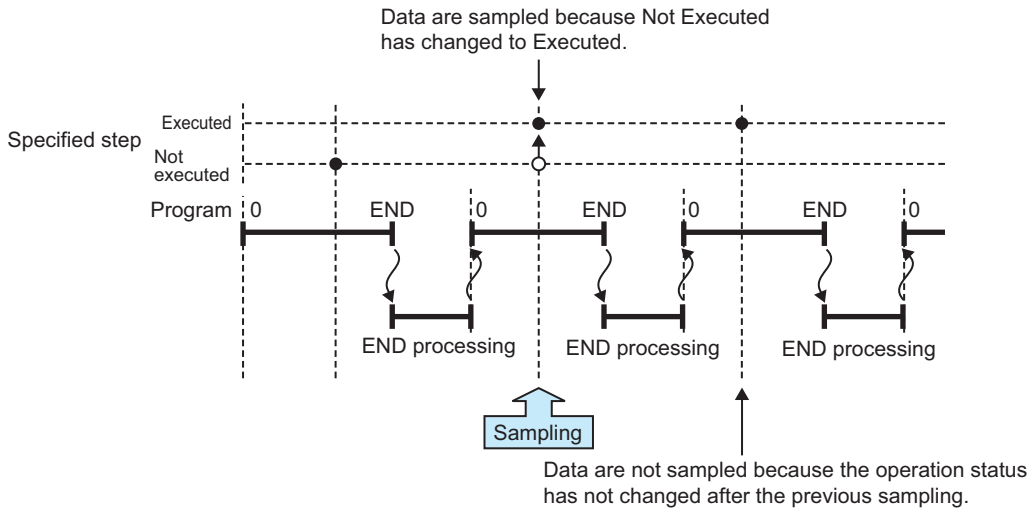

Point

- Data are collected when the status immediately before execution of the specified step changes to the specified status.
- With the High-speed Universal model QCPU and Universal model Process CPU, only the first data which satisfies the specified conditions is collected if the step between the FOR and NEXT instructions is specified.

6.3 Logging Type

There are three logging types:

- Continuous logging
- Trigger logging
- Specification period logging

6.3.1 Continuous logging

When continuous logging is selected, device values of the CPU module are continuously logged at the specified intervals. The flow of the continuous logging is shown below.

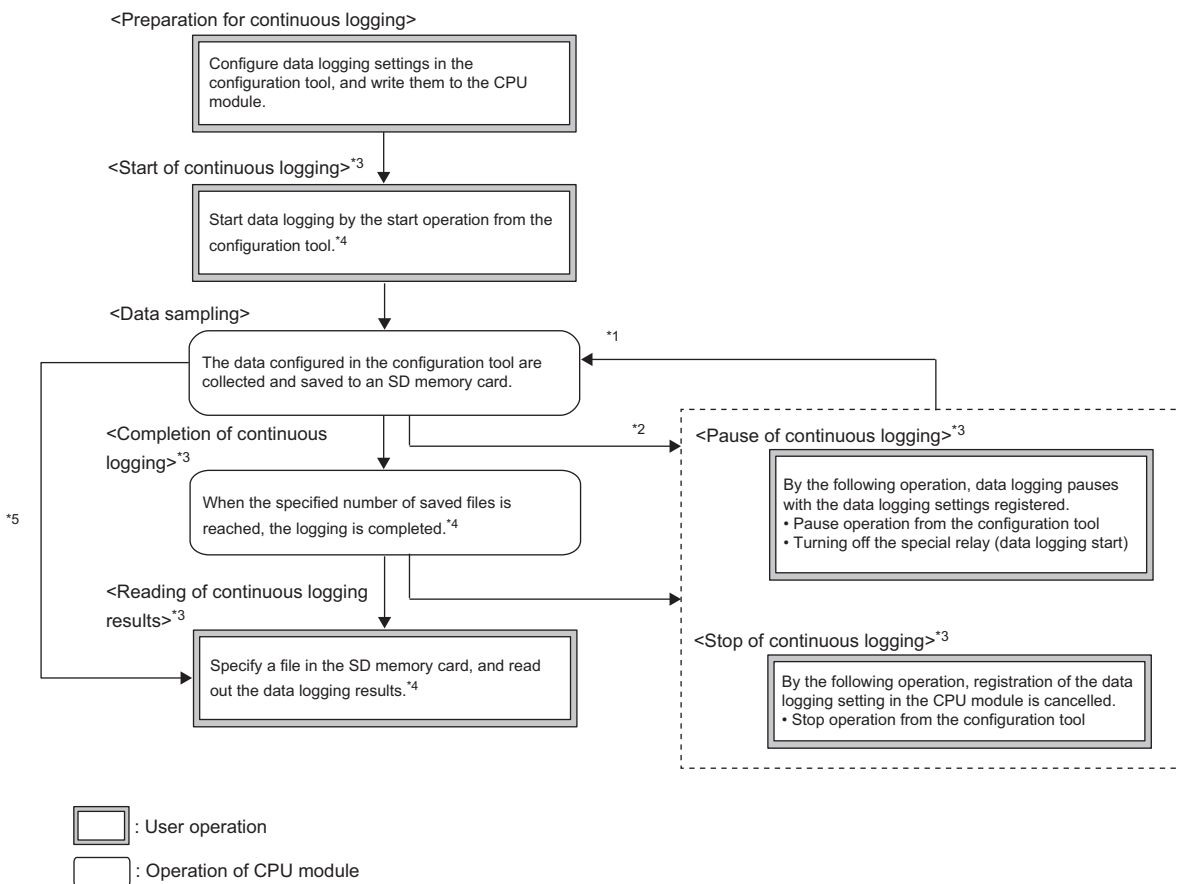

*1 Data logging can be resumed by performing the following from the pause status.

- Start operation from the configuration tool (Page 131, Section 8.4.14)
- Turning on the special relay (Data logging start)

*2 Logging data are regarded as being saved until the entire buffer data are saved in the SD memory card.

*3 For the data logging status, refer to Page 63, Section 6.4.

*4 For the configuration tool, refer to Page 95, CHAPTER 8.

*5 The data logging results can be read because the data logging file is created even when the data logging has not been completed.

6.3.2 Trigger logging

When trigger logging is selected, device values of the CPU module before and after a trigger (satisfaction of the specified condition) are logged for the specified number of records. The flow of the trigger logging is shown below.

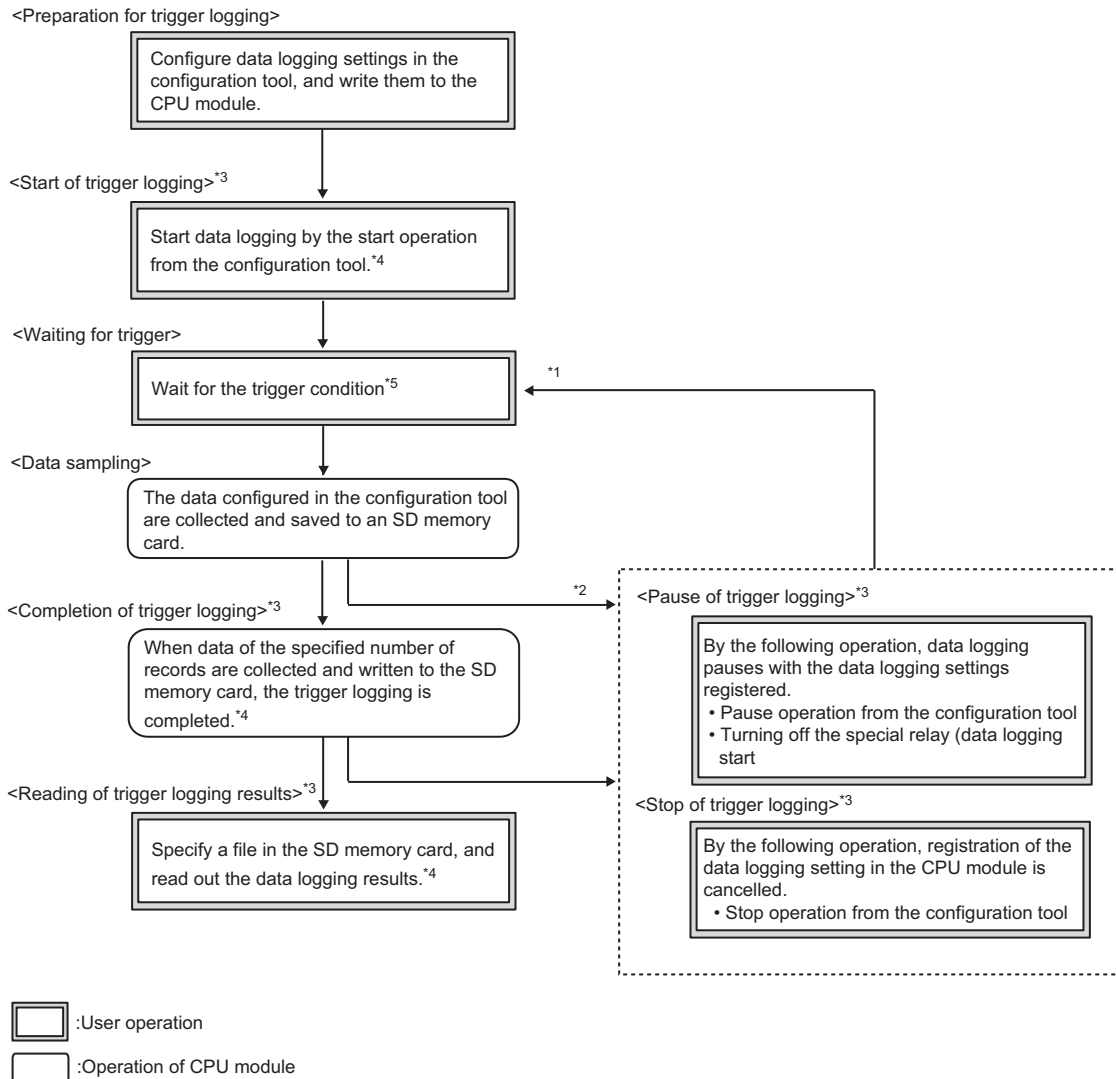

*1 Data logging can be resumed by performing the following from the pause status.

- Start operation from the configuration tool (☞ Page 147, Section 8.9)
- Turning on the special relay (Data logging start)

*2 Logging data are regarded as being saved until the entire buffer data are saved in the SD memory card.

*3 For the data logging status, refer to ☞ Page 63, Section 6.4.

*4 For the configuration tool, refer to ☞ Page 95, CHAPTER 8.

*5 For the trigger condition, refer to ☞ Page 59, Section 6.3.2 (1).

Specify the numbers of records before and after trigger in the following setting. (☞ Page 124, Section 8.4.10)

Setting item	Description
No. of records (before trigger)	Specify the volume of the data sampled before trigger as the number of records.
No. of records (after trigger)	Specify the volume of the data sampled after trigger (including at the time of trigger) as the number of records.

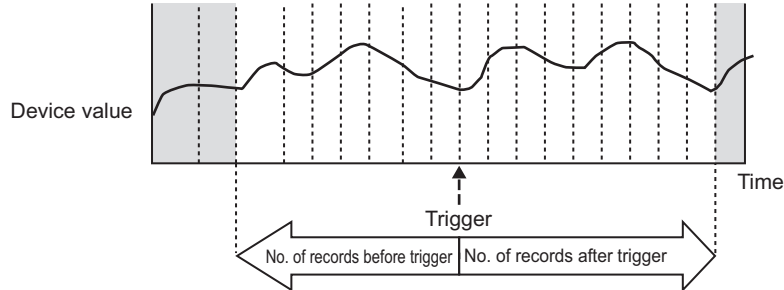

Point

After starting data logging, if the trigger condition is met before data collection of the specified number of records (before trigger) is completed, the number of sampled records will be less than the specified.

With trigger logging setting, the specified data are collected at the specified interval or timing. Data of the specified number of records before and after the trigger are extracted from the collected data, and saved in a data logging file in the SD memory card.

Note that, in addition to the specified interval or timing, data are also collected when the trigger condition is met.

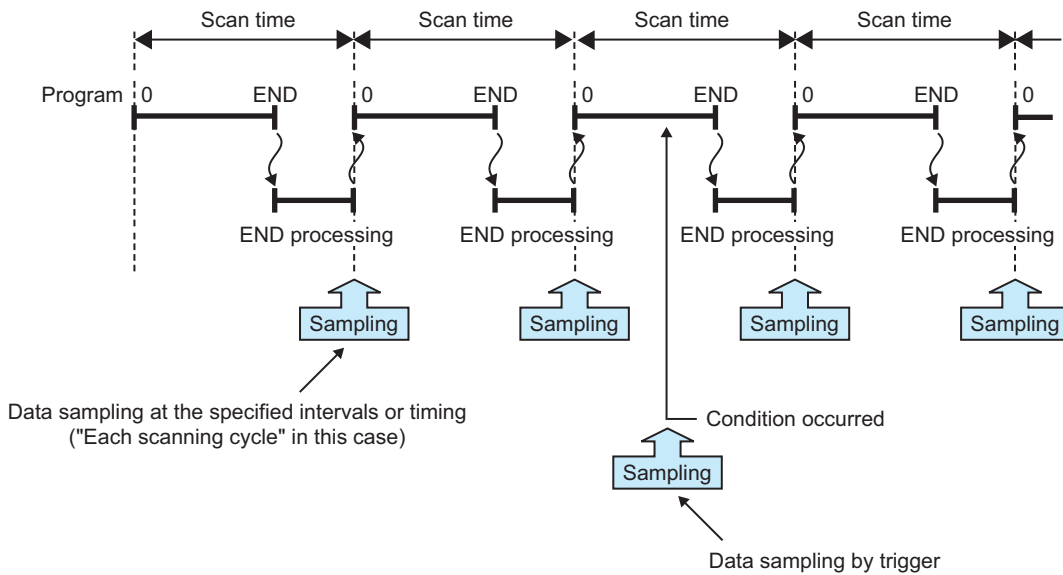

(1) Trigger condition

Specify a trigger condition by selecting appropriate items from the following.*1 (☞ Page 121, Section 8.4.8)

Setting item		Description	
Condition specification	Device change specification	When the bit of the bit device rises	A trigger occurs when the status of the specified device is changed from off to on.
		When the bit of the bit device falls	A trigger occurs when the status of the specified device is changed from on to off.
		When the word device value meets the specified value	A trigger occurs when the data that match the specified value are written*2, regardless of the current value status of the specified device (match or not match with the specified value).
		When data are written to a word device	A trigger occurs when data are written*2 to the specified device.
	Step No. specification	Always	A trigger occurs any time regardless of the operation status of the specified step.
		When execution condition is ON	A trigger occurs any time but only during operation execution of the specified step.
		When execution condition is OFF	A trigger occurs only not during operation execution of the specified step.
		When execution condition rises	A trigger occurs when the operation nonexecutable status of the specified step is changed to the executable status.
		When execution condition falls	A trigger occurs when the operation executable status of the specified step is changed to the nonexecutable status.
	When trigger instruction executed		A trigger occurs when the trigger logging set instruction (LOGTRG) is executed.
When data logging trigger activated		A trigger occurs when the special relay (Data logging trigger) is turned on.	

*1 The following cases are not regarded as trigger conditions.

- When a trigger condition is met again after occurrence of the trigger
- When a trigger condition is met with no data sampling performed

*2 A trigger will also occur in a case other than program execution (such as link refresh, transient update, or a device test conducted from a peripheral device).

(a) Condition specification

A trigger occurs when the state of the specified device or step meets the specified condition.

- Device change specification

A trigger occurs when the specified device condition is met. Select one from the following.

Item	Description
When the bit of the bit device rises	When the specified device is turned on
When the bit of the bit device falls	When the specified device is turned off
When the word device value meets the specified value	A trigger occurs when the data that match the specified value are written, regardless of the current value status of the specified device (match or not match with the specified value).
When data are written to a word device	When data are written to the specified device

The following devices can be specified as trigger conditions.

Type	Description
Bit device	X, Y, M, L, F, SM, V, B, SB, T (contact)*1, ST (contact)*1, C (contact)*1, FX, FY
	Bit specification of word device: D, D (extended data register), SD, W, W (extended link register), SW, R, ZR, FD
Word device	T (current value), ST (current value), C (current value), D, D (extended data register), SD, W, W (extended link register), SW, R, ZR, FD

*1 T (contact), ST (contact), and C (contact) are specified with TS, SS, and CS respectively.

For the above devices, index modification and indirect specification are not available.

- Step No. specification

A trigger occurs when the specified condition is met immediately before execution of the specified step. In addition to "Step No.", set "Program name" and "Execution condition". Select an execution condition from the following.

Item	Description
Always	Any time regardless of the operation status immediately before the execution of the specified step
When the specified condition is ON	The operation status immediately before the execution of the specified step is the Executed state.
When the specified condition is OFF	The operation status immediately before the execution of the specified step is the Not Executed state.
When the specified condition rises	The operation status immediately before the execution of the specified step has changed from Not Executed to Executed.
When the specified condition falls	The operation status immediately before the execution of the specified step has changed from Executed to Not Executed.

Ex. When the specified condition rises

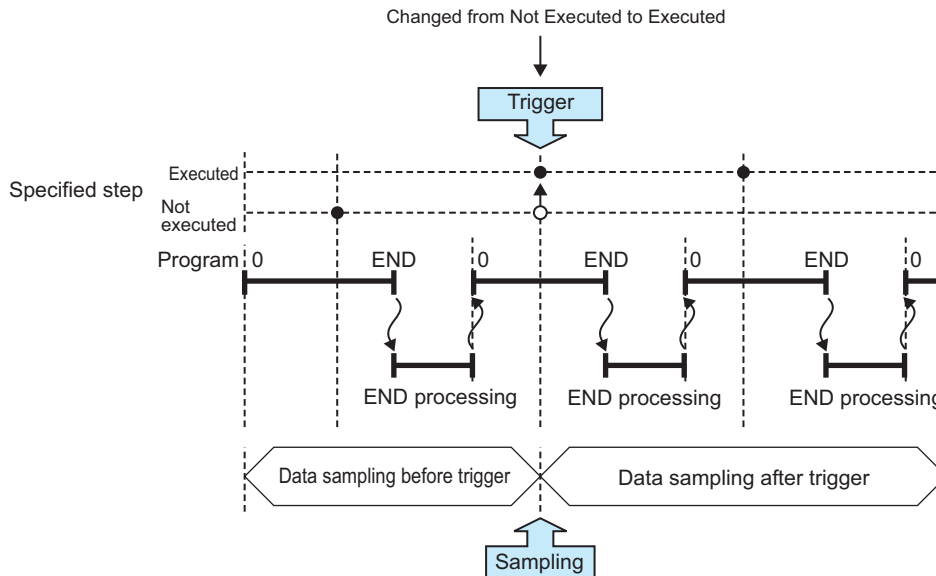

Point

- A trigger occurs when the status immediately before execution of the specified step changes to the specified status.
- With the High-speed Universal model QCPU and Universal model Process CPU, a trigger occurs only when the specified conditions are satisfied for the first time if the step between the FOR and NEXT instructions is specified.

(b) When trigger instruction executed

A trigger occurs when an instruction is executed. For instructions used for data logging, refer to Page 170, CHAPTER 11.

(c) When data logging trigger activated

A trigger occurs when the special relay (Data logging trigger) is turned on. For the list of the special relay and special register used for data logging, refer to Page 178, CHAPTER 12.

6.3.3 Specification period logging

When specification period logging is selected, specified devices are sampled while specified conditions are met. Specification period logging is used to check only the specified devices while the specific conditions are met.

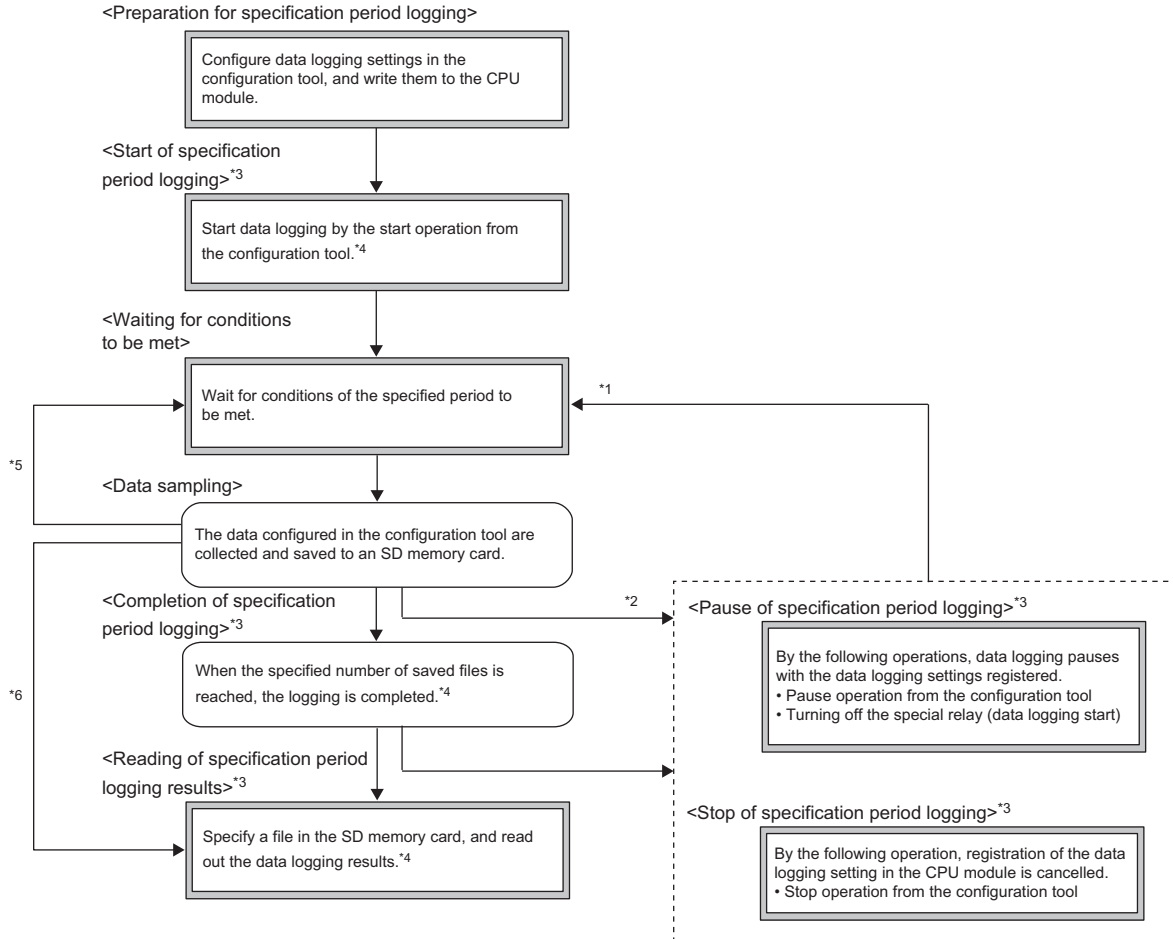

: User operation
 : Operation of CPU module

- *1 Data logging can be resumed by performing the following from the pause status.
 - Start operation from the configuration tool (☞ Page 131, Section 8.4.14)
 - Turning on the special relay (Data logging start)
- *2 Logging data are regarded as being saved until the entire buffer data are saved in the SD memory card.
- *3 For the data logging status, refer to ☞ Page 63, Section 6.4.
- *4 For the configuration tool, refer to ☞ Page 95, CHAPTER 8.
- *5 When the conditions of the specified period are not met, the CPU module waits for conditions of the specified period to be met.
- *6 The data logging results can be read because the data logging file is created even when the data logging has not been completed.

Remark

Specification period logging is available only for the High-speed Universal model QCPU and the Universal model Process CPU. Before using the specification period logging, check the versions of the CPU module and configuration tool used. (☞ Page 190, Appendix 2)

(1) Specification period

Select conditions treated as the specification period from the following items.

Setting item		Description	
Condition specification	Device	When the bit device is on	Data are sampled while the specified device is on.
		When the bit device is off	Data are sampled while the specified device is off.
		When the word device value meets the specified value	Data are sampled while the current value of the specified device is equal to the condition value.

(a) Conditions of the specified period

Whether the specified conditions are met is judged in the END processing of each scan. When the conditions are met in the END processing, data are sampled for a specified period or at a specified timing until the conditions are not met in the subsequent END processing.

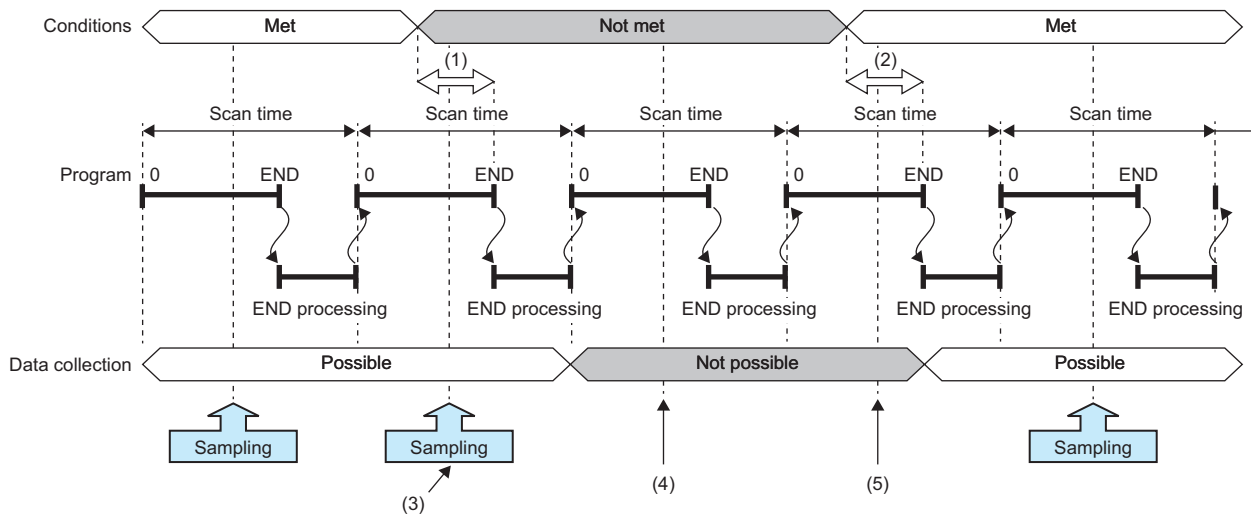

- (1) Even when the conditions are not met, data can be sampled until the judgment whether the conditions are met is made in the END processing.
- (2) Even when the conditions are met, data cannot be sampled until the judgment whether the conditions are met is made in the END processing.
- (3) Even when the conditions are not met, data are sampled because the data sampling is possible during this period.
- (4) Data are not sampled because the data sampling is not possible during this period.
- (5) Even when the conditions are met, data are not sampled because the data sampling is not possible during this period.

(b) Condition specification

When the conditions of the specified device are met, data are sampled for a specified period or at a specified timing. Select the setting from the following.

- When the bit device is on: Data are sampled while the specified device is on.
- When the bit device is off: Data are sampled while the specified device is off.
- When the word device value meets the specified value: Data are sampled when the current value of the specified device is equal to the condition value.

The following devices can be specified as device data conditions.

Type	Description
Bit device	X, Y, M, L, F, SM, V, B, SB, T (contact) ^{*1} , ST (contact) ^{*1} , C (contact) ^{*1} , FX, FY
	Bit specification of word device: D, D (extended data register), SD, W, W (extended link register), SW, R, ZR, FD
Word device	T (current value), ST (current value), C (current value), D, D (extended data register), SD, W, W (extended link register), SW, R, ZR, FD

*1 T (contact), ST (contact), and C (contact) are specified with TS, SS, and CS respectively.

For the above devices, index modification and indirect specification are not available.

6.4 Data Logging Status

There are four data logging status levels:

- Start
- Pause
- Stop
- Completion

(1) Start

By a data logging start request, register a data logging ^{*1} and start it. Data logging start can be requested by the following:

- Start operation from the configuration tool ( Page 149, Section 8.10)
- Turning on the special relay (Data logging start)

*1 Data logging can be registered by the following:

- Power off → on
- Reset
- STOP → RUN
- Auto logging start

(2) Pause

With the data logging setting registered, the data logging is stopped temporarily. The following operation and status causes a pause.

- Pause operation from the configuration tool ( Page 149, Section 8.10)
- Turning off the special relay (Data logging start)
- The CPU module is in the STOP status. (Including a stop error)

(3) Stop

Registration of the data logging setting in the CPU module is canceled. The following stops data logging.

- Stop operation from the configuration tool ( Page 149, Section 8.10)

Point

Latch clear will clear the data logging status, and make it unregistered. To execute data logging again, start it from the configuration tool. Also, if "Format PLC Memory" is executed to the memory where the currently executing data logging file is stored, the data logging status will be cleared and left unregistered. To execute the data logging again, write the configuration of the data logging, and then start it from the configuration tool.

(4) Completion

Data logging is completed with the data logging setting registered. Perform the following.

(a) For continuous logging

In the "Save" setting of the data logging setting, when "Stop" is selected for "Operation occurring when number of saved files is exceeded", the data logging is completed at the time the number of saved files reaches the specified value.

(b) For trigger logging

After sampling the data, of which number of records is specified in the "Number of records" setting of the data logging setting, and after saving them to an SD memory card, the data logging is completed.

6.5 Data Logging File

The target data of the data logging are saved in the data logging file.

6.5.1 Saving format of the data logging file

Data logging files are saved in the CSV format (the extension is ".CSV"). The CSV file format is a format of the files that can be opened by general applications, such as Excel and Notepad. For the CSV file output format, refer to [Page 37, Section 3.3](#).

6.5.2 How sampled data are saved

The following shows how sampled data are saved to an SD memory card.

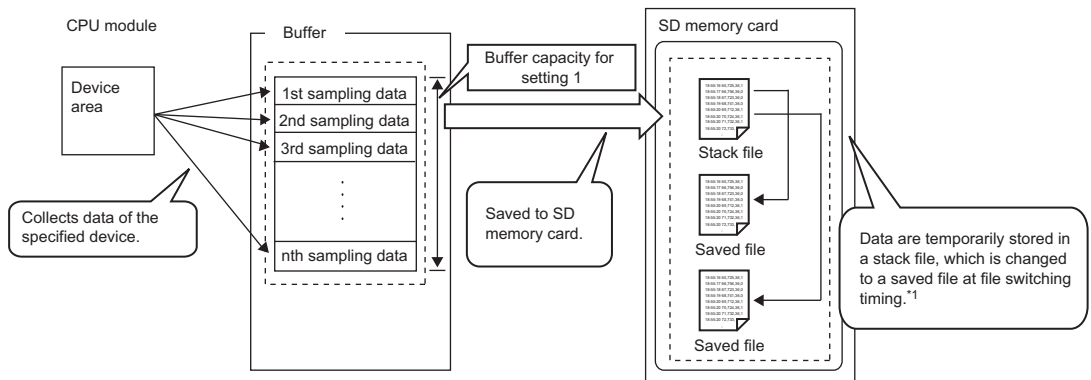

*1 For the file switching setting, refer to [Page 65, Section 6.5.3](#).

Sampled data are stored in the specified buffer. The data in the buffer are saved to the SD memory card at the timing of file saving. If all available space of the buffer is used up, the old data that have already been saved to the SD memory card will be overwritten in chronological order.

6.5.3 File switching setting

The sampled target data of data logging are temporarily saved in a stack file*¹ in the SD memory card. The stack file can be switched to the saved file so that the size of the stack file will not be too large. By renaming the stack file, it can be switched to a saved file. (After change of the file name, a new stack file is created.)

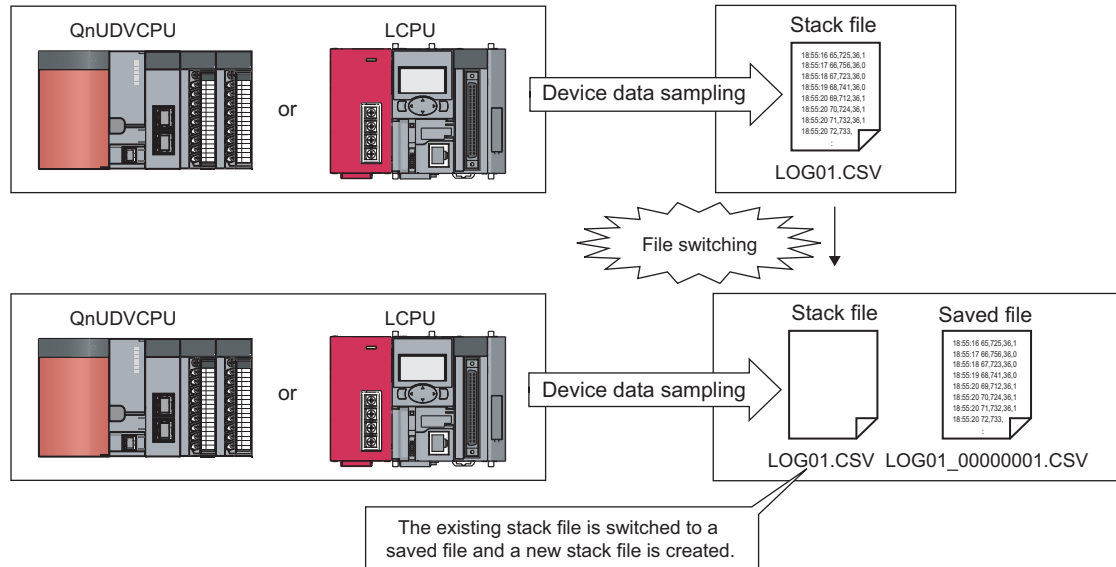

*¹ The LCPU adds null data after the sampled target data and stores the data in a stack file. When referring to the data in the stack file, see the one before the null data.

When specification period logging is selected, the stack file is switched to the storage file not only at a file switching timing, but also when the conditions of the specification period are not met.

(1) File switching timing

Files are switched at the following timing. This setting is available only for continuous logging or specification period logging.

(☞ Page 127, Section 8.4.12)

Switching timing	Setting range
When the specified number of records is reached	100 to 65500 records
When the specified file size is reached	10 to 16384 k bytes

Note that, regardless of the setting, the file is switched in the following cases.

- The number of records reached 65500.
- The file size reached 16M bytes.
- By changing the status from RUN to STOP or performing stop operation, the data logging paused or stopped.
- Data logging is started while a stack file exists.

A number is appended to each file name until the specified number is reached, and the files are stored in the SD memory card. When the specified number is exceeded, old files are deleted and new files are created.

(2) File after switching

In renaming a file, an eight-digit serial number (hexadecimal) is appended to the original file name. The following information can be also added if the number of characters is 48 or less (including an extension and periods).

Type of information	Information added
Folder name	The folder name specified as a location where a stack file of the sampling data is saved
Date	Date information in the following format: Year (4 digits): YYYY, Month (2 digits): MM, Day: (2 digits): DD
Time	Time information in the following format: Hour (2 digits): hh, Minute (2 digits): mm, Second (2 digits): ss

Ex. When all of the information is added: LOG01_20091201_171530_00000001

↑ ↑ ↑ ↑
 Folder name Date Time Number

The following shows file names given when saved folders and additional information are not attached to them. In each folder of the specified file storage destination, up to 256 files are stored.

Folder ^{*1}			File name (CSV file)	
LOGGING	\[File destination 1]	\00000001	00000001.CSV	1st
			00000002.CSV	2nd
			:	:
			000000FF.CSV	:
		\00000101	00000100.CSV	256th
			00000101.CSV	257th
			00000102.CSV	:
			:	:
	\[File destination 2]	\00000001	00000001.CSV	1st
			00000002.CSV	2nd
			:	:
			000000FF.CSV	:
		\00000101	00000100.CSV	256th
			00000101.CSV	257th
			00000102.CSV	:
			:	:
		000001FF.CSV	:	

*1 File destination 1 and File destination 2 are specified at the destination to save.

(3) Storage location of saved files

A folder is created under the destination folder, and saved files are stored in the folder. Up to 256 files can be stored in each folder. (When the maximum number of files has been reached, a new folder is created in the next file switching, and the file storage location after file switching is changed.)

The number of files that can be stored in a destination folder is set within the range of 1 to 65535.

(4) When the maximum number of files to be saved is exceeded

Either of the following can be selected in the case of exceeding the maximum number of files to be saved. (Page 127, Section 8.4.12)

- Overwrite
- Stop

(a) When "Overwrite" is selected

After the number of saved files is reached, the oldest file with the smallest number is deleted and a new file with "the largest number plus one" is created to continue data logging. Also, as a result of file deletion, if no file exists in a folder, the folder will be deleted.

(b) When "Stop" is selected

The operation differs depending on the following timing.

Timing	Condition	Operation
At start of data logging	Files more than the specified number of saved files exist when data logging is started.	When the start is instructed from the configuration tool, an error message is returned and data logging is not executed. When the start is instructed from any other than the configuration tool, the special relay (Data logging error) turns on, and information on the cause of the error is stored in the special register (Data logging error cause). Data logging is not executed.
During execution of data logging	File switching occurs due to the timing set in the File switching timing setting, and because of this, the specified number of saved files is reached.	The data logging is completed and stopped. The special relay (Data logging completion) turns on.

Point

The number of saved files is calculated with the file numbers as follows.
(when no file is deleted among the saved files of the smallest to the largest numbers)
Latest file number - Oldest file number + 1

6.6 Buffer Capacity

Buffer capacity means the size of the buffer that is used to temporarily store collected data.

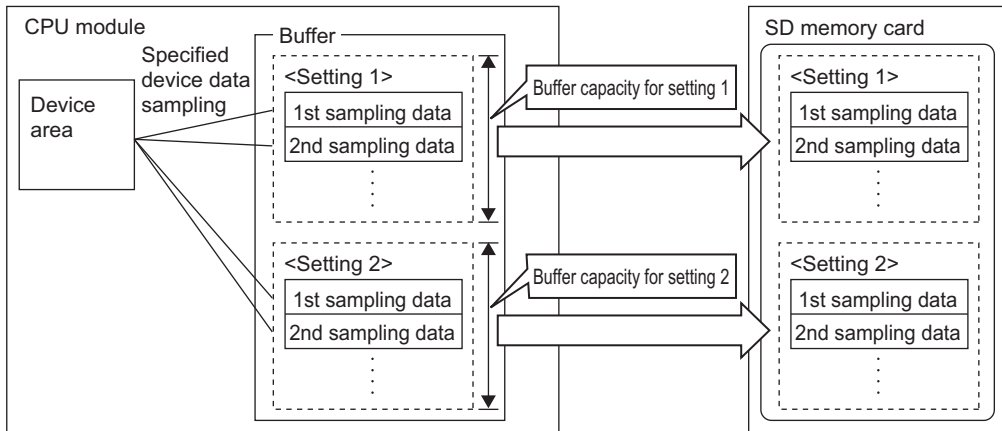

Sampled data are stored in the specified buffer. The data in the buffer are saved to the SD memory card at the timing of file saving.

Item	Setting range
Data logging buffer capacity	For each setting, any of 32 to 4832K bytes (in increments of 1K byte) can be specified. The total capacity for the settings No.1 to No.10 is 5120K bytes (maximum).

(1) Buffer capacity setting

Increasing the buffer capacity enables the following.

- Continuous logging: Processing overflow occurs less frequently.* 1
- Trigger logging: The number of sampled data is increased.
- Specification period logging: Processing overflow occurs less frequently.* 1

*1 Adjust the buffer capacity while checking the special register (Free buffer space). When the free buffer space is insufficient even though the buffer capacity is increased, perform the following actions.

- Increase the sampling interval. (☞ Page 115, Section 8.4.4)
- Decrease the number of sampled data. (☞ Page 117, Section 8.4.5)
- Decrease frequency of file switching. (☞ Page 127, Section 8.4.12)
- Cancel the "File Transfer" setting in the data logging setting. (☞ Page 129, Section 8.4.13)

To consider the processing time taken to data logging, refer to ☞ Page 161, CHAPTER 10.

(2) Buffer utilization

The buffer utilization can be obtained by a formula, "number of device points × 2 bytes + 2 bytes". Note that, if output of the following column is selected, the corresponding amount is increased.

- Date column: 10 bytes
- Data sampling interval column: 8 bytes
- Execution step No. column: 10 bytes
- Execution program name column: 8 bytes
- Index column: 4 bytes

Ex. Outputting data in all columns as data to be sampled by data logging when 128 points is assigned to one setting (Maximum setting)

$$128 \times 2 + 2 + (10 + 8 + 10 + 8 + 4) = 298 \text{ bytes}$$

6.7 Data Missing

When some of the data to be sampled is not obtained and data are not successively collected, this state is called missing.

(1) Cases of data missing

Data missing occurs in the following cases.

Item	Description
Processing overflow	Processing overflow occurs at the specified sampling interval or timing.
CPU module operation	When "Auto Start" is set in the Operation at transition to RUN setting, the CPU module is set to RUN, STOP, and RUN again.
	When "Auto Start" is set in the Operation at transition to RUN setting, the CPU module is powered off and on.
	When "Auto Start" is set in the Operation at transition to RUN setting, the CPU module is reset.
Operation by the special relay	The special relay (Data logging start) is turned off and on.
Operation by the configuration tool	After sampling pauses by the operation from the configuration tool, a start operation is performed.

(2) Missing due to processing overflow

If data sampling is performed at short intervals and processing is not completed within the interval, data writing from devices to the buffer is not possible, resulting in missing of sampled data. The following two factors cause processing to overflow.

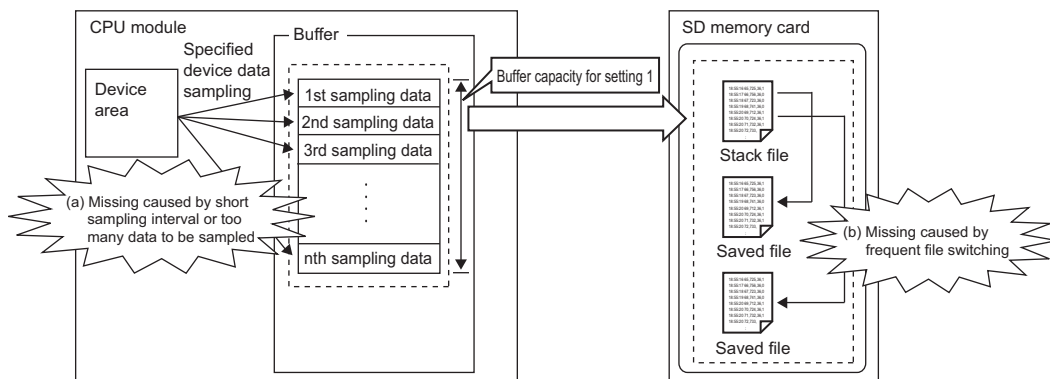

(a) "The data sampling interval is too short." or "Too many data are to be sampled."

If the speed of saving data in the buffer exceeds that of saving data to the SD memory card, the buffer will be full of sampled but non-overwritten data (that are not yet saved to the SD memory card). Because data cannot be written from the device area to the buffer, data will be missed.

(b) File switching occurs frequently.

During file switching, data are not saved from the buffer to the SD memory card. If file switching occurs frequently, the buffer will be full of sampled but non-overwritten data (that are not yet saved to the SD memory card). Because data cannot be written from the device area to the buffer, data missing will occur.

(c) When the data logging file transfer function is used

During file transfer by the data logging file transfer function, data are not saved from the buffer to the SD memory card. Therefore, the buffer will be full of sampled but non-overwritten data (that are not yet saved to the SD memory card) soon, compared when the data logging file transfer function is not used. Because data cannot be written from the device area to the buffer, data will be missed.





(d) When other functions are used

When the following functions are used, the data sampling performance of data logging is deteriorated.

- Project data batch save/load function (applicable to the LCPU only)
- iQ Sensor Solution data backup/restoration function

Therefore, data missing may occur even with the data logging settings with which it did not occur previously. Also, with a setting with which data missing occurred previously, the frequency of data missing may increase.

Point

- Once missing occurs, it tends to recur afterward. The following settings can reduce frequency of missing.
 - Increase the sampling interval. ( Page 115, Section 8.4.4)
 - Decrease the number of sampled data. ( Page 117, Section 8.4.5)
 - Increase the buffer capacity. ( Page 135, Section 8.5.2)
 - Decrease frequency of file switching. ( Page 127, Section 8.4.12)
 - Cancel the "File Transfer" setting in the data logging setting. ( Page 129, Section 8.4.13)

To consider the processing time taken to data logging, refer to  Page 161, CHAPTER 10.

- When sampling cannot be completed within the specified sampling interval due to execution of an instruction of which processing time is long (such as the FMOV instruction), it is not regarded as data missing.
-

6.8 SD Memory Card Life When the Data Logging Function is Used

Each SD memory card has its limit on writing data. This section describes how to calculate the life of an SD memory card when the data logging function is used. Use the calculated limit for reference since the actual life of the card varies depending on the use conditions and environment.

(1) Calculation formula

SD memory card life (year) = Total size of data that can be written (G bytes) ÷ Size of data to be written per year (G bytes/year)

(2) Total size of data that can be written

Capacity × Number of writes

- *1 For the capacity of applicable SD memory cards and the number of writes, refer to the following.
 User's Manual (Hardware Design, Maintenance and Inspection) for the CPU module used

(3) Size of data to be written per year

The size of data to be written per year is obtained by the following formula.

Size of data to be written per year (G bytes/year) = $((DS1^{*1} + 6144) \times DN1 + \dots + (DSn^{*1} + 6144) \times DNn + (DCS1^{*1} + 6144) \times DCN1 + \dots + (DCSn^{*1} + 6144) \times DCNn) \div 1073741824$

- *1 Round up DS_n and DCS_n to a multiple of 512.
 DS_n, DN_n, DCS_n, and DCN_n are obtained as follows:

(a) Data logging data size per record (DS_n)

CSV file output format: Refer to (5) in the following section. ( Page 37, Section 3.3.2)

(b) Number of records for data logging per year (DN_n)

- Continuous logging: $DNn = 60 \times 60 \times 24 \times 365 \div \text{Collection interval and timing (seconds)}^{*1} \times \text{Operating rate}^{*2}$
- Trigger logging: $DNn = \text{Total number of records}^{*3}$
- Specification period logging: $DNn = 60 \times 60 \times 24 \times 365 \div \text{Collection interval and timing (seconds)}^{*1} \times \text{Specification period logging operating rate}^{*4}$

- *1 A value that is determined depending on the condition set in "Sampling" when "Continuous logging" is selected for the logging type. (When the value is determined in milliseconds, convert the value into seconds.)
 *2 Calculate the ratio according to the operating time of the CPU module per year. For example, if the operating time per year is 5000 hours, the operating rate is 0.57 ($5000 \div (24 \times 365)$).
 *3 A value set in "No. of records" when "Trigger logging" is selected for the logging type
 *4 Calculate the operating rate according to the total time during which the conditions of the specification period are met on the CPU module per year. For example, if the total time of the specification period per year is 2500 hours, the operating rate is 0.28 ($2500 \div (24 \times 365)$).

(c) Header size of data logging (DCS_n)

CSV file output format: Refer to "File information line" to "Data name line" in the following section. ( Page 37, Section 3.3.2)

(d) Number of data logging file switching times per year (DCNn)

Calculate this number with an estimated number according to the save setting of the data logging and system operations. For example, when 1000 records are set in "Nnumber of records" of "File switching timing" in the save setting and "Each scanning cycle" is specified for "Sampling interval" in the sampling setting, the time interval of the file switching is obtained by multiplying the scan time by 1000. For this reason, the number of data logging file switching times per year is obtained by the following formula: $60 \times 60 \times 24 \times 365 \div (\text{Scan time (second)} \times 1000)$.

6.9 Precautions to Take When Using the Data Logging Function

This section describes precautions for using the data logging function.

(1) Exclusive processing

(a) Sampling trace during data logging execution

Sampling trace is not executable during data logging execution.

(b) Data logging during sampling trace execution

Sampling trace continues normally, and an error is detected in data logging.

(c) Online change during data logging execution

When a value is specified for "Step No." in "Sampling" or "Trigger", online change continues normally, and an error is detected in data logging.

(d) Data logging during online change execution

When a value is specified for "Step No." in "Sampling" or "Trigger", online change continues normally, and an error is detected in data logging.

(e) CPU module change by using an SD memory card during data logging execution

CPU module change by using an SD memory card is not executable during data logging execution.

(f) Data logging during execution of CPU module change by an SD memory card

CPU module change by using an SD memory card continues normally, and an error is detected in data logging.

(g) Concurrent execution of data logging and real-time monitor

If the sum of the total buffer capacity used in the data logging function and the total buffer capacity used in the real-time monitor function exceeds 5120K bytes, the function that has been executed at a later time results in an error. When executing these functions concurrently, adjust the sum of the buffer capacity used in each function to not more than 5120K bytes.

(h) PLC memory formatting during data logging execution

While sampled data are being saved from the buffer to an SD memory card, PLC memory formatting cannot be performed to the memory where the setting file of the currently executing data logging is stored.

(i) Data logging during execution of PLC memory formatting

PLC memory formatting continues normally, and an error is detected in data logging.

(2) Multiple trigger logging settings

In multiple trigger logging settings, the following causes an error at start of data logging.

- Specifying a device in "Condition specification" of "Trigger".

(3) Holding and clearing the data logging setting

The data logging setting registered to the CPU module is latched. Even if the CPU module is powered off and on or is reset, the data logging can be performed again with registered setting data. However, the data logging status is cleared when the storage destination is an SD memory card and any of the following conditions is met. Write the setting data again.

- The CPU module is powered off and on or is reset with the SD memory card removed.
- When the CPU module change function with SD memory card is used, the CPU module is powered off and on or is reset with no setting data stored in the SD memory card. (If the SD memory card after replacement contains setting data, registration is performed with the data.)

(4) Availability of data logging

Data logging can be executed through another station or a serial communication module on the network. For the same setting number, however, simultaneous execution by multiple routes is not allowed.

(5) Execution of data logging

Once data logging is started, it can be executed only with the memory where the setting file of the currently executing data logging is stored. (A data logging setting file stored in a different memory cannot be used.)

(6) Start operation after stop of trigger logging

When data logging is restarted after stop or temporary stop of data logging before completing trigger logging, data are collected from the initial status before the trigger.

(7) When data logging registration failed

If a part of multiple data logging settings fails to be registered, successfully registered data loggings only will be executed. Note that, however, registration by auto logging is different in operation.

( Page 78, Section 7.2 (2))

(8) Sampling interval setting in "Sampling"

When "Time specification" is set for the sampling interval in "Sampling", sampling is executed as interrupt processing. Therefore, scan time will be extended and a watchdog timer error may occur in the following cases.

- Short sampling interval and many data logging executions per scan
- Large volume of data to be sampled, and long data logging processing time

(9) Checking the sampling interval

Depending on the accuracy of the clock, some errors may be observed in the information output to the "Date" column. Check the sampling intervals with the information output to the "Sampling interval" column. For the accuracy of the clock, refer to the following.

 User's Manual (Hardware Design, Maintenance and Inspection) for the CPU module used

(10) When a file register is specified

When a file register is specified in "Device specification" in "Sampling" or "Trigger", do not change the block numbers and file name of the file register after registration of the data logging. Doing so may disable normal collection of logging results.

(11)When "Sampling" is set to "Step No. specification"

With "Sampling" set to "Step No. specification", the processing time of data logging is added to the program running time. Accordingly, when "Step No. specification" is specified, design watchdog timer settings and interrupt programs with a consideration of the processing time of data logging (setting the fixed scan interval).

(12)Sampled data being saved to an SD memory card

If the CPU module is powered off or reset while data in the buffer is being saved to an SD memory card, unsaved data will be cleared. However, data will be saved without being cleared in the following cases.

- Status change from RUN to STOP
- Pause caused by turning off the special relay (Data logging start)
- Stop or pause operation from the configuration tool
- Execution of the trigger logging reset instruction (LOGTRGR)

(13)Changing clock data

Do not change clock data of the CPU module during execution of data logging. Doing so will cause incorrect "Date" column information to be output to the CSV file. (Even if clock data are changed, data are collected at the specified intervals or timing. Therefore, changed clock data will be output in the Date column of the CSV file.)

(14)Sampling timing when the display unit is attached

An error of up to $\pm 100\mu\text{s}$ may occur in the sampling timing when the display unit is attached.

Ex. A time value is set for "Time specification" of "Sampling", without setting of data sampling at the END processing.

(15)Removing the SD memory card

When data logging is being executed with the data logging setting stored in an SD memory card, the corresponding bit of SD604 (Memory card use conditions) turns on.

Because of this, the following LEDs do not turn off when the removal operation is performed.

- SD CARD LED of the High-speed Universal model QCPU and Universal model Process CPU: when the SD memory card access control switch is pressed for 1 second or longer
- SD LED of the LCPU: when the SD memory card access control switch is slid up

To remove the SD memory card in the above case, stop the data logging processing and remove the SD memory card again. For details on the removal procedure, refer to the following. For details on the removal procedure, refer to the following.

 User's Manual (Hardware Design, Maintenance and Inspection) for the CPU module used

(16)Using data that are set by a CPU module of a different series

If the High-speed Universal model QCPU or Universal model Process CPU executes data logging using the settings stored in an SD memory card by a CPU module of a different series, an error occurs. ( Page 180, Section 13.1)

Since the LCPU can use the settings stored in an SD memory card by a CPU module of a different series, no error occurs.

(17)When the CPU module is locked with a security key

No device comment can be output to the data logging file.

(18)Disabling the addition of character string by the data logging file name addition instruction when the data logging is registered

When the data logging is registered by writing of data logging setting of the target setting number after the data logging file name addition instruction (SP.LOGFILES instruction) is executed, addition of a character string executed by this instruction is disabled. (The bits corresponding to the setting numbers of SD710 to SD712 are turned off.) Therefore, execute the instruction again when adding a character string. ( Page 177, Section 11.3 (3))

CHAPTER 7 OTHER FUNCTIONS

This chapter describes the functions other than the data logging function.

7.1 Data Logging Operation at Transition to RUN

After registration of a data logging setting, logging operation for the following transition to RUN can be specified. Setting is available for each of setting No.1 to No.10. (☞ Page 131, Section 8.4.14)

(1) Relevant operations

The relevant operations are shown below.

- Power-on → RUN
- Reset → RUN
- STOP → RUN

(2) Selectable operations

Select an operation from the following.

- Auto Start
- Start by User Operation

(a) When "Auto Start" is selected

Data logging is automatically started after the operation listed above.

Point

To start the data logging at the first time, the user must perform a specific operation.

(b) When "Start by User Operation" is selected

Data logging is temporarily stopped after the operation listed above. To restart the data logging, the user must perform a specific operation.

Point

When the auto logging function is enabled, even if "Start by User Operation" is set, the same operation as "Auto Start" is performed.

7.2 Auto Logging by Inserting an SD Memory Card

Writing auto logging settings to an SD memory card and inserting it into a running CPU module will automatically start logging. All of continuous logging, trigger logging, and specification period logging are executable. Individual setting is not available for each of setting No.1 to No.10. (☞ Page 134, Section 8.5.1)

(1) Procedure to use

The following is the procedure to use the auto logging function.

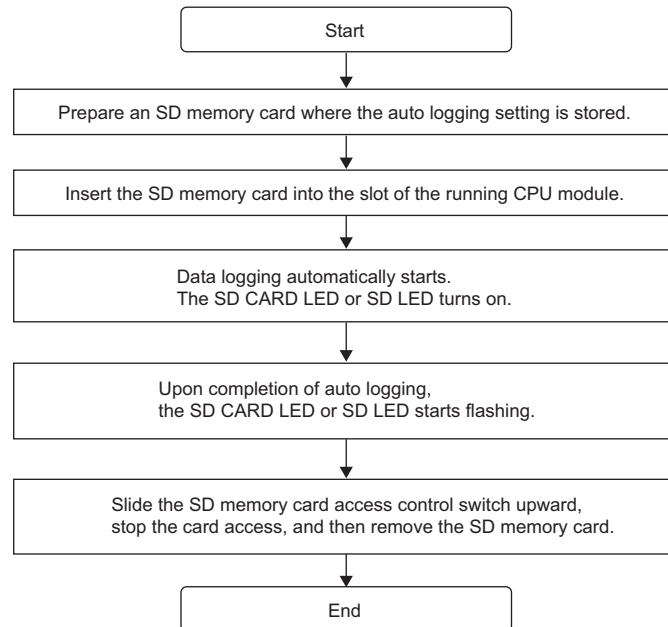

Point

- A new data logging cannot be started during auto logging operation.
 - After completion of auto logging, replace the SD memory card where the auto logging settings are stored. Otherwise, another auto logging cannot be started.
-

(2) When data logging registration by the auto logging function failed

When multiple data logging settings are registered by the auto logging function, if a part of them has failed to be registered, all of data logging will not be executed.

(3) Conditions for auto logging completion

When one of the following conditions is met, the auto logging is terminated. The following conditions can be set in combination. In that case, the auto logging is terminated when either of the conditions is met first.

Condition	Setting
Data logging stop	Select one from the following. <ul style="list-style-type: none"> • When all data loggings stop • When any of the data loggings stops
Timer	Select "Complete with timer". Setting range for "Elapsed time": 1 to 86400 seconds (in increments of 1s)

(a) When "Data logging stop" is set

The auto logging is terminated when all or any of the configured data loggings is stopped.

Data logging stop is defined as follows:

- Continuous logging: The number of saved files in the Save setting is exceeded, and data logging is completed.
- Trigger logging: Data of the specified number of records have been collected and written to the SD memory card, and data logging is completed.
- Specification period logging: The number of saved files in the Save setting is exceeded, and data logging is completed.
- Data logging is stopped from the configuration tool.

Point

- When continuous logging or specification period logging is selected for a data logging for which auto logging is enabled, if "Overwrite" is selected in the "Number of saved files" setting, the data logging will not be terminated. Therefore, select "Stop".
- If "When any of the data loggings stops" is selected, operation of a data logging in execution, which is other than the stopped one, is the same as the operation performed after the time specified with the timer has elapsed.

(b) When "Timer" is set

After start of data logging execution, when operating time reaches the specified time, all of the data collected until then are saved on the SD memory card, and the auto logging is completed. However, for trigger logging, if data of the specified number of records have not been collected yet, the data including collected data will not be saved.

Point

If a data logging is temporarily stopped before completion of auto logging and then restarted, the timer is cleared to zero. However, when a temporary stop is caused by turning off the special relay (Data logging start), the timer continues running even while the data logging is temporarily stopped.

(4) Conditions for auto logging inactivation

After completion of auto logging, the following operation does not start another auto logging.

- Power off → on
- Reset
- STOP → RUN

Also, auto logging does not start even if the following operation is performed with an SD memory card (with the auto logging setting) inserted.

- Power off → on
- Reset

(5) Operation when the status is changed to RUN

When the auto logging function is enabled for multiple data logging settings, if the following is performed with a part of data logging completed and then the status is changed to RUN, unfinished data loggings only will be started.

- Power off → on
- Reset

(6) When an error occurs

When an auto logging error occurs, the operation is as follows:

(a) Registration failure at start of auto logging

When auto logging was not executed due to registration failure at the start of auto logging, the operation will be the same as the one performed upon completion of auto logging.

(b) Error occurred during auto logging execution

Even if an error occurs during auto logging execution and the data logging is stopped, it can be restarted by turning on the special relay (Data logging start). Because of this, the error is not included in the conditions for auto logging completion. However, when online change is performed during auto logging execution, the data logging cannot be restarted although it is also detected as an error. Therefore, this is included in the conditions for auto logging completion. *1

*1 Only when "When all data loggings stop" is selected

7.3 File Access

The FTP server function allows saving and deletion of data logging files from the SD memory card installed in the CPU module to the personal computer. The following commands can be used for access. When a file is to be specified, use a command for which a folder name can be included. Available commands are shown below.

Command	Function	Command	Function
delete	Deletes a file.	mdir	Stores file information in a file.
mdelete	Deletes files.	ls	Displays a file name.
get	Reads a file.	mls	Stores a file name in a file.
mget	Reads files.	rename	Changes a file name.
dir	Displays file information.	quote change	Displays or changes a file attribute.

Remark

For details on command specification, refer to the following.

- 📖 QnUCPU User's Manual (Communication via Built-in Ethernet Port)
- 📖 MELSEC-L CPU Module User's Manual (Built-In Ethernet Function)

7.4 Data Logging File Transfer Function

Remark

Before using the function with the LCPU, check the versions of the CPU module and configuration tool used. (Page 190, Appendix 2)

This function supports the client function of the FTP (File Transfer Protocol), a protocol for file transfer with external devices. By using the data logging file transfer function, the CPU module serves as an FTP client, and data logging files in SD memory cards can be transferred to the FTP server. Since data logging files can be managed by one FTP server, data management and maintenance work can be reduced.

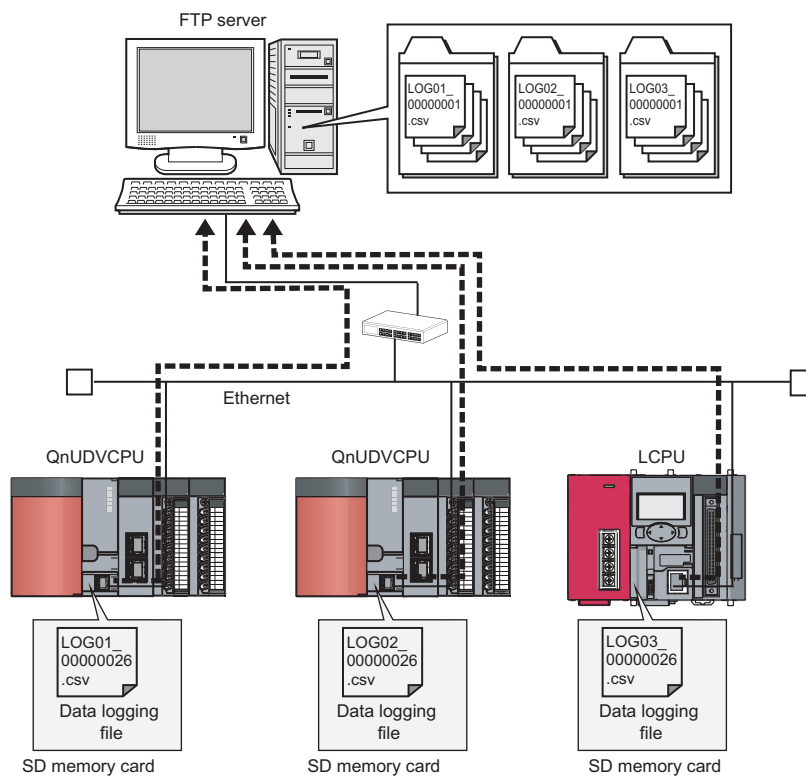

Point

The data logging file transfer function requires an FTP server. For details on the server, refer to the manual for the server used.

7.4.1 Procedure overview of the data logging file transfer function

The following flowchart lists a procedure for performing the data logging file transfer function.

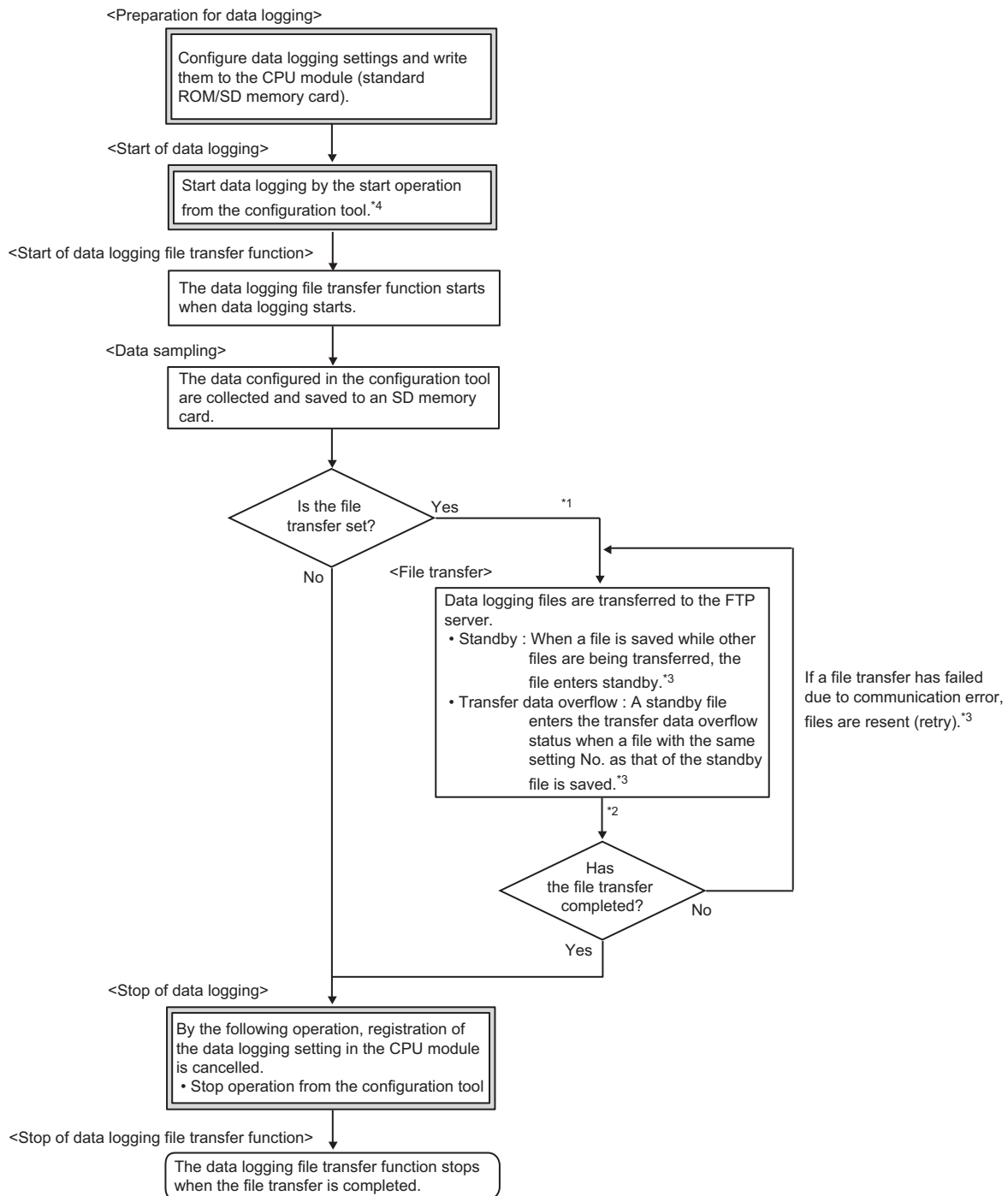

 : User operation

 : Operation of CPU module

*1 Check that the CPU module is connected to the target server using a file transfer test before performing file transfer. ( Page 88, Section 7.4.4)

*2 Transfer status can be checked using file transfer diagnostics. ( Page 89, Section 7.4.5)

*3 For the start operation from the configuration tool, refer to  Page 149, Section 8.10.

*4 For the file transfer status, refer to  Page 85, Section 7.4.3.

7.4.2 Directory structure of the FTP server

When data logging files are transferred, a folder is automatically created in the specified directory path on the FTP server, and the data logging files are saved in the folder.

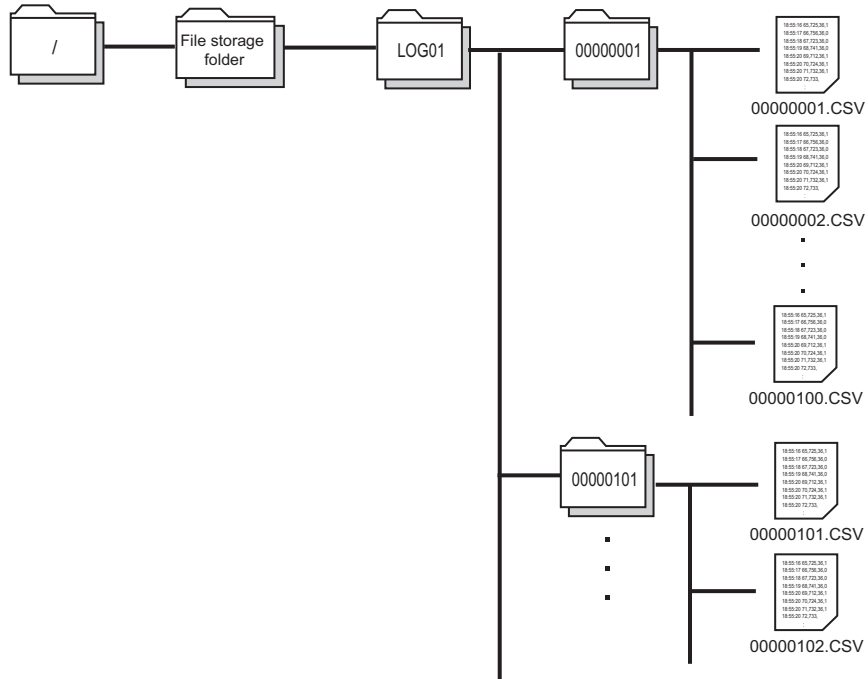

Point

When files are simultaneously transferred from different CPU modules to one FTP server, they may overwrite each other. Specify a different directory path as a storage location of each file.

7.4.3 File transfer status

There are five file transfer status levels:

- Transfer start
- Standby
- Transfer data overflow
- Retry
- Transfer completion (stop)

(1) Transfer start

Data logging files of each setting No. are transferred one by one. Data logging file transfer starts simultaneously with the data logging start operation, and the special relay (Data logging file transfer execution status flag) turns on.

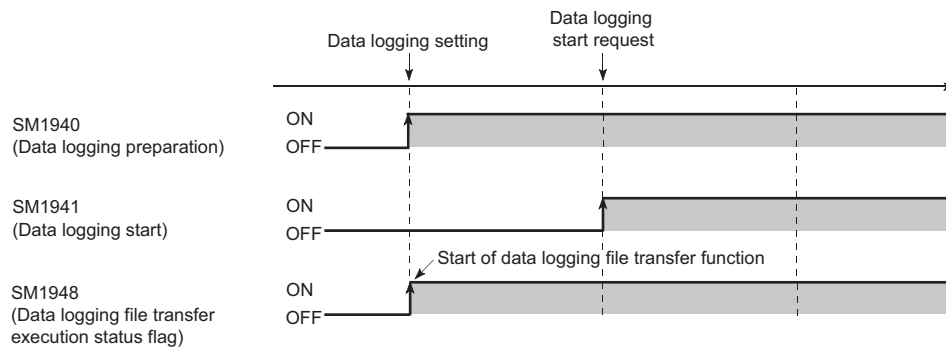

(2) Standby

When a data logging file is newly saved during data logging file transfer, the new file enters standby. Only one data logging file enters standby in each setting No. If a data logging file with the same setting No. as the standby file is saved, the standby file enters transfer data overflow status. (Page 86, Section 7.4.3 (3))
 After completion of the ongoing transfer processing, a standby data logging file is started to be transferred. When there are several standby data logging files, they are transferred in the order that they are saved in the SD memory card.

Ex. When a data logging file of setting No.4 is saved while data logging files are on standby in the order of setting No.2 and setting No.3

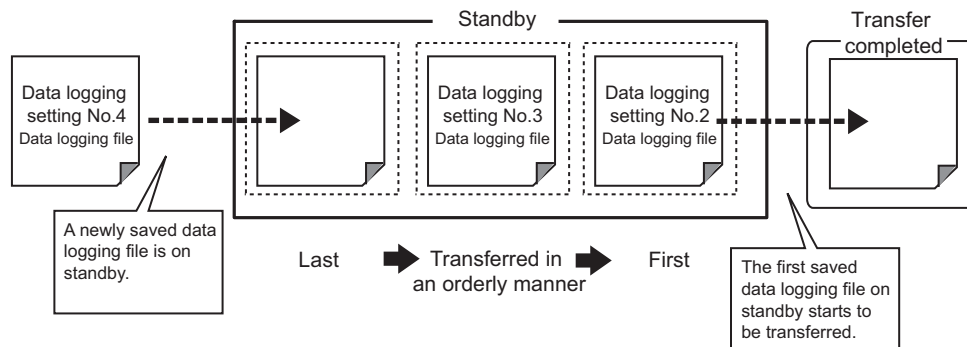

(3) Transfer data overflow

If a data logging file with the same setting No. as a standby file is saved, the standby file will not be transferred.

Ex. When a data logging file of setting No.2 is saved while a data logging file of setting No.2 is on standby

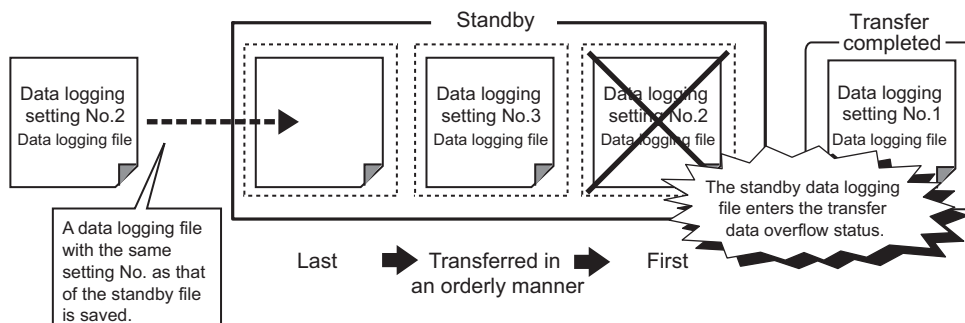

Point

If transfer data overflow frequently occurs, the frequency can be reduced by taking the following actions:

- Increase the sampling interval. (☞ Page 115, Section 8.4.4)
- Decrease the number of sampled data. (☞ Page 117, Section 8.4.5)
- Decrease frequency of file switching. (☞ Page 127, Section 8.4.12)

If transfer data overflow still frequently occurs even after the above actions are taken, settings (e.g. "Save" and "Sampling" settings) configured for other data logging setting Nos. should be changed. Correct settings for other data logging setting Nos. of files during transfer processing.

(4) Retry

If data logging file transfer failed due to network failure between the CPU module and the FTP server, the data logging file not yet transferred is repeatedly sent until the network returns to normal.

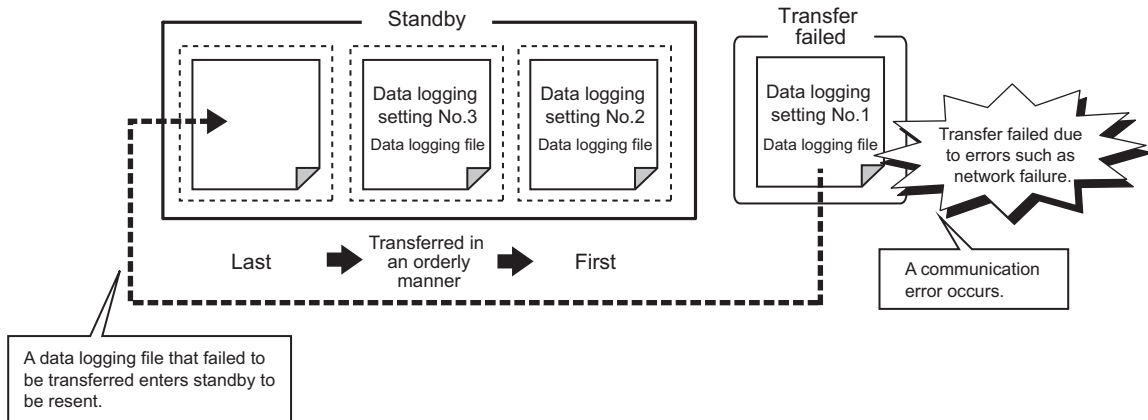

The retry processing ends when the network returns to normal and file transfer is completed. However, even if file transfer fails, the processing ends when any of the following conditions is met:

- Retransmission of data logging files failed due to an error other than communication error
- Retransmission failed after the elapse of the retry time ^{*1}
- The file enters transfer data overflow status.
- File transfer is stopped during retry by forced stop. (☞ Page 91, Section 7.4.6 (6))

*1 Refers to the time from retry start to file retransmission. (☞ Page 129, Section 8.4.13)

Point

Only the latest data logging file is retransferred when network returns to normal. When retransmitting the untransferred file before the network returns to normal, use stack logging file transfer. (☞ Page 92, Section 7.4.7)

(5) Transfer completion (stop)

Files enter transfer completion status when the data logging stop operation is performed and all data logging files with the same setting No. have been transferred. When file transfer is completed, the special relay (Data logging file transfer execution status flag) turns off.

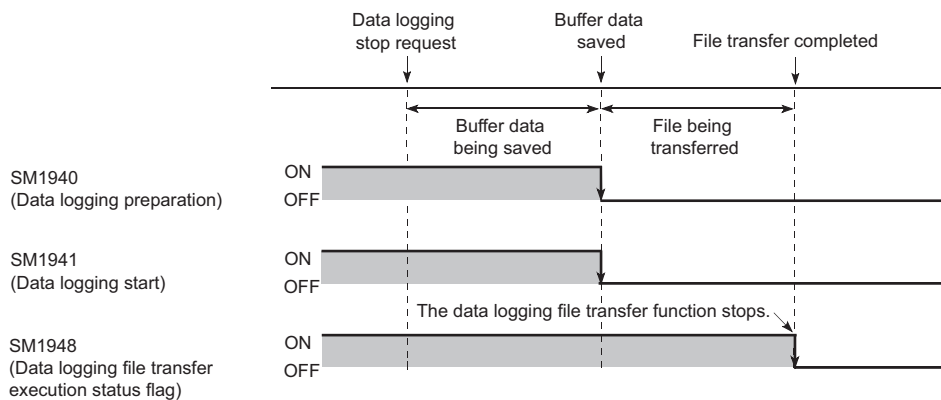

7.4.4 File transfer test

Communication status and settings between the CPU module and the FTP server can be checked by transferring a test file from the CPU module to the FTP server. Since this function can be executed without starting or stopping data logging, file transfer operation can be checked before system operation.

(1) Procedure

The following describes a procedure for file transfer test.

1. Configure destination server settings using configuration tool. (☞ Page 129, Section 8.4.13)
2. Click the  button in the "FTP Setting" window to execute a file transfer test.

 [Data logging Setting] ⇒ [File Transfer] ⇒ [Server Setting]

3. Check the test result in the displayed window.
4. Check if the test file has been transferred in the directory path on the FTP server.

(2) Test file structure

The following describes a test file structure to be transferred to the FTP server.

(a) Test file name

MELSEC_CPU_FTP_TEST_data logging setting No..txt

A test file of setting No.1 has the following file name:

MELSEC_CPU_FTP_TEST_01.txt

(b) Information in a test file

A test file contains the IP address of the CPU module, date and time when the test is executed.

 192.168.10.39_20101001_170230
 ↑ ↑ ↑
 IP address Date Time

Point

- Even if a file transfer test failed due to a communication error, file transfer will not be performed again.
 - A file transfer test cannot be simultaneously executed from multiple configuration tools. Execute a file transfer test after the ongoing test is ended.
 - In a file transfer test, "FTP Server Connection Request Timeout Time" is fixed to 10 seconds.
-

7.4.5 File transfer diagnostics

This function stores file transfer status of the data logging file transfer function.

(1) File transfer status

The transfer status can be checked in the "Data Logging File Transfer Status" window. (☞ Page 154, Section 8.12)

 [Online] ⇒ [Data Logging File Transfer Status]

The following lists the transfer status:

- "—": "File transfer" in the data logging setting is not set.
- "Stopped": The data logging file transfer function is stopped.
- "Retrying": The data logging file transfer function is being retried.
- "Transferring": A file is being transferred by the data logging file transfer function.
- "Waiting for transfer": A file is on standby for transfer.*¹ When the data logging file transfer function is used

*¹ Even if data logging status is "Completed" or "Pausing", file transfer status is in "Waiting for transfer".

Point

If the CPU module is powered off and on or is reset during file transfer, data logging files not yet transferred will not be transferred.

(2) File transfer error log

Error logs can be checked in the "File Transfer Error Log" window. (☞ Page 154, Section 8.12)

 [Online] ⇒ [Data Logging File Transfer Status] ⇒  button

Up to 30 error logs can be stored. (If errors are collected more than 30, an error log is deleted from the oldest one.) Error logs are held when the CPU module is powered off and on or is reset.

7.4.6 Precautions for using the data logging file transfer function

This section describes precautions for using the data logging file transfer function.

(1) Concurrent execution of another function

(a) Auto logging function

The data logging file transfer function cannot be performed during auto logging.

(b) Functions of a programming tool

If either of the following functions is executed from a programming tool during data logging file transfer, an error may occur. An error also may occur in a standby data logging file and a data logging file during retry processing.

- SD memory card formatting
- CPU module change function with SD memory card

(2) Sampling performance

When the data logging file transfer function is used, the sampling performance is degraded, compared when the function is not used. Therefore, data missing may occur even if it did not occur when the data logging file transfer function was not used. If data missing had occurred before the function is used, the frequency of data missing may rise. (☞ Page 69, Section 6.7)

(3) IP address setting for Ethernet communication

In the data logging file transfer function, data logging files are transferred to the FTP server through built-in Ethernet ports of the CPU module. Set "IP Address" in the "Built-in Ethernet Port Setting" tab using a programming tool.

☞ QnUCPU User's Manual (Communication via Built-in Ethernet Port)

☞ MELSEC-L CPU Module User's Manual (Built-In Ethernet Function)

(4) Port numbers when the socket communication function is used

For the data logging file transfer function, own station port numbers, F000_H to FFFE_H, are used for FTP communication. Do not specify F000_H to FFFE_H using the connection establishment instruction for the socket communication function (SP.SOCOPEN) during execution of the data logging file transfer function.

☞ QnUCPU User's Manual (Communication via Built-in Ethernet Port)

☞ MELSEC-L CPU Module User's Manual (Built-In Ethernet Function)

(5) Processing time of file transfer

Time taken to file transfer depends on a load placed on the Ethernet line (congestion of the line), operating status of other communication functions, and system configuration.

(6) Starting data logging during file transfer

Another data logging cannot be started to the same file being transferred. If the start operation is performed, the following window appears. Select whether to start the data logging or not.

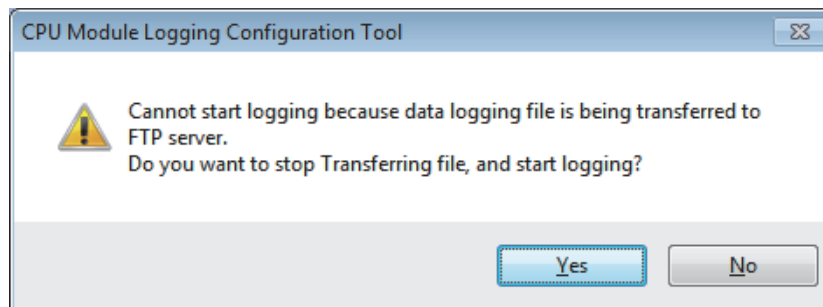

Clicking "Yes" will stop transferring data logging files. (Files not yet completely transferred may remain on the FTP server. Standby data logging files (including files during retry processing) will no longer be on standby, and an error will occur.)

(7) Data logging file that results in a file transfer error

If an error caused by communication error, file access error, or file transfer stop error occurs during file transfer, data logging files not yet completely transferred may remain on the FTP server. Since unreliable, the logging files should not be referred to (Data logging files in file transfer error can be checked in the "File Transfer Error Log" window).

(8) Latch clear during data logging file transfer

If latch clear is executed during data logging file transfer, data logging status will be unregistered. The operation will be in the same status when the data logging stop operation is performed.

(9) Powering off and on or resetting the CPU module during data logging file transfer

If the CPU module is powered off and on or is reset during data logging file transfer, data logging files not yet completely transferred may remain on the FTP server. Note that transfer of a standby data logging file (including a file that were in retry process) and a data logging file that was being transferred will not be resumed.

7.4.7 Stack logging file transfer

Remark

Check the versions of the CPU module and configuration tool used when using this function with the LCPU. (Page 190, Appendix 2)

This function cannot be used with the High-speed Universal model QCPU and Universal model Process CPU.

Transfer the untransferred data logging file when switching file due to the network failure by using data logging file transfer function to the FIP server. The data logging file made during network failure can be transferred when the network recovered because the order of file transfer is decided.

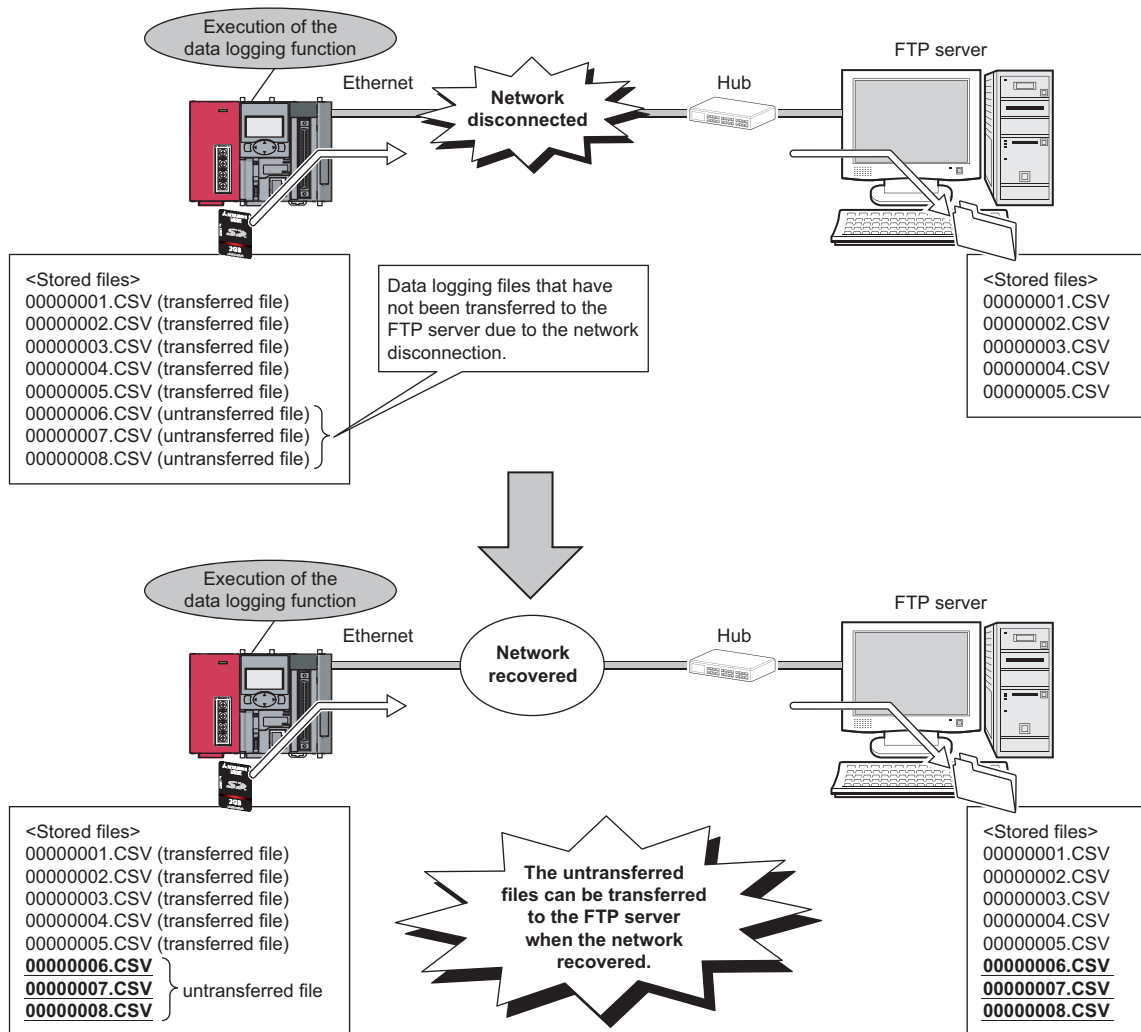

(1) Setting methods

Settings for the stack logging file transfer is set by "File transfer" in data logging settings. (☞ Page 129, Section 8.4.13)

(2) File transfer

(a) Order

Files are transferred in order from a small number of file names within the data logging setting number.

(b) Timing of transfer

If the next transfer file has already been stored when the file transfer is completed, the next file is transferred sequentially. If the next file has not yet been stored, the file is transferred when switching file.

Ex. When data logging setting No.1 file (00000001.csv) is completed, the next data logging setting No.1 file (00000002.csv) of has already been stored.

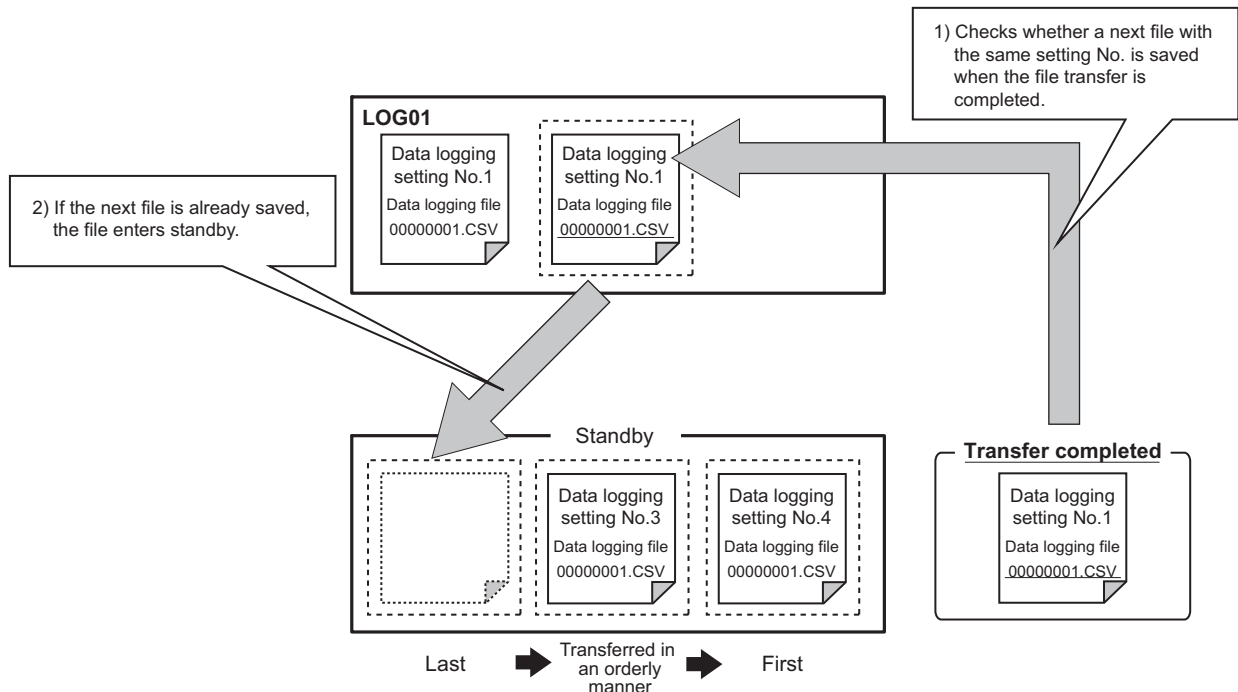

(3) Retransmission

With the stack logging file transfer, a file is repeatedly sent until the file transfer is completed. When retransmitting of the file is completed, check the next file and transfer sequentially until all stored files are transferred.

7.4.8 Transfer completing/Non-completing file distinction indication

Remark

Check the versions of the CPU module and configuration tool used when using this function with the LCPU. (☞ Page 190, Appendix 2)
This function cannot be used with the High-speed Universal model QCPU and Universal model Process CPU.

For the data logging file in the SD memory card, character string "C_" (abbreviated designation of "Complete_") is added to a file name after file transfer completion to the FTP server. Only checking the file name of the data logging file in the SD memory card can distinguish at first sight whether the file has been transferred to the FTP server.

Ex. File name before the transfer: LOG01_00000001.CSV
File name after the transfer: C_LOG01_00000001.CSV

Point

Only a saved file of the data logging function is a target of the character string "C_" addition.

(1) Setting methods

Settings for the stack logging file transfer is set by "File transfer" in data logging settings.
(☞ Page 129, Section 8.4.13)

(2) Cautions

- The saved file name can be set up to 46 characters (including the extension and period) to add the character string for two characters to the file name by the transfer completion/non-completion file distinction indication.
- When an abnormal completion is encountered as a result of an error during file transfer, character string "C_" is not added to it.

CHAPTER 8 HOW TO USE THE CONFIGURATION TOOL

This chapter describes the setting procedure and operations for data logging.

8.1 Setting Flow Chart

Follow the flow chart below to configure the settings.

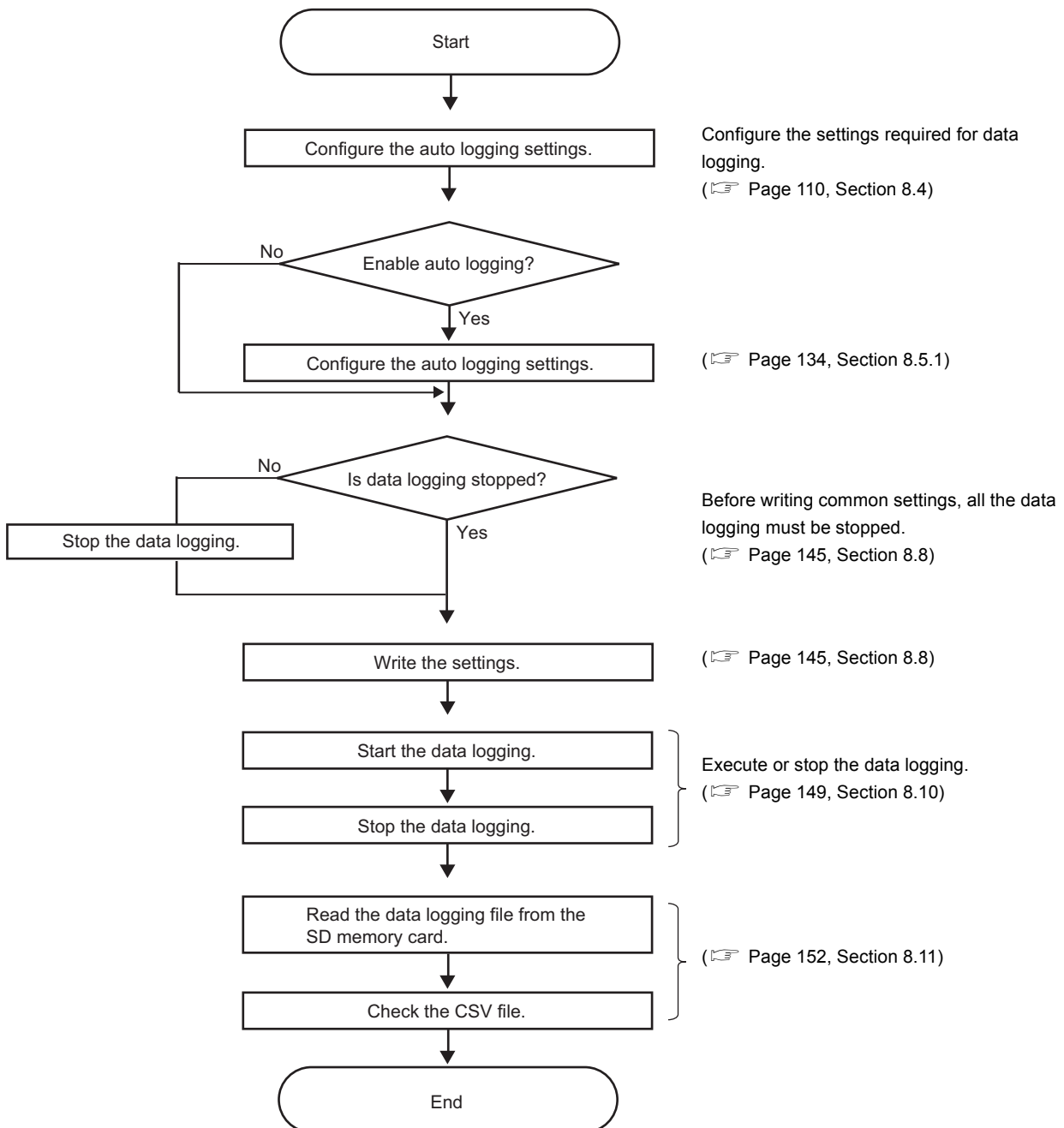

8.2 Window Structure

This section describes the window structure of the configuration tool.

8.2.1 Main window

The main window of the configuration tool is as shown below.

(1) Displayed window

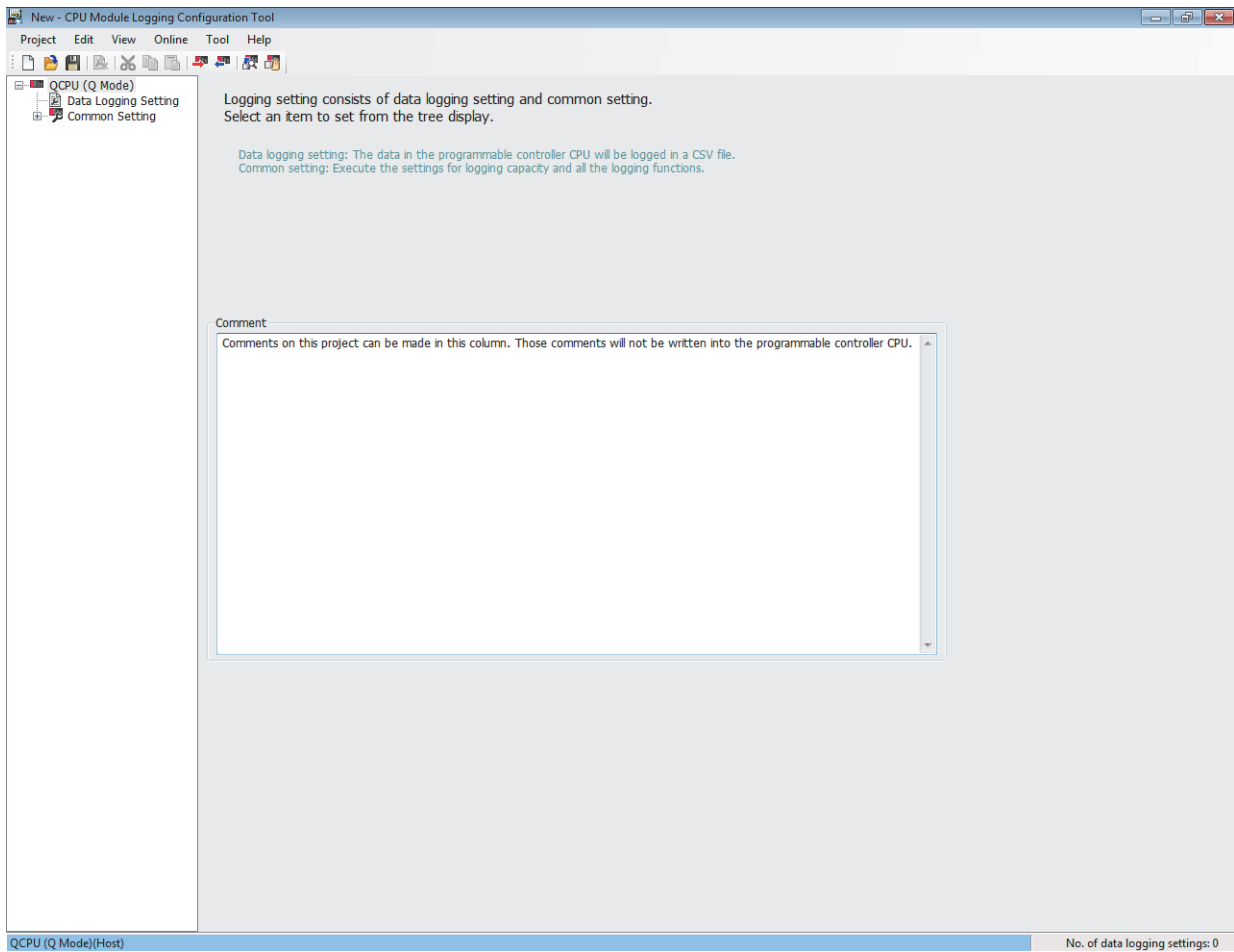

(2) Displayed items

Name	Description	Reference
Menu	Menu items used for executing respective functions are displayed.	Page 97, Section 8.2.2
Toolbar	Tool buttons used for executing respective functions are displayed.	Page 98, Section 8.2.3
Edit item tree	When an item on the tree is selected, the corresponding advanced settings area is displayed.	Page 99, Section 8.2.4
Comment	A comment about the project can be entered. This comment is not written to the CPU module. Up to 1024 one-byte characters (512 two-byte characters) can be entered.	—
Status bar	Information on the current project is displayed.	Page 100, Section 8.2.5
Advanced settings area	A setting area for each function is displayed.	—











8.2.2 Menu structure

The menu structure of the configuration tool is as listed below.

Project		Reference
New	Creates a new project, discarding the currently editing project.	Page 103, Section 8.3.1
Open	Opens a project file that is stored in the local disk.	Page 103, Section 8.3.2
Save	Saves the current project data to the current file.	Page 104, Section 8.3.3
Save as	Saves the current project file with a different name.	
Change PLC series	Changes the programmable controller series of the project being edited.	Page 105, Section 8.3.4
Read Logging Setting from Memory Card (SD)	Reads the data logging setting written on an SD memory card in the personal computer.	Page 106, Section 8.3.5
Write Logging Setting into Memory Card (SD)	Writes the currently editing data in a form available for CPU module operation. Data are written directly to the SD memory card in the personal computer. When the SD memory card is installed into the CPU module, logging is started.	Page 108, Section 8.3.6
Recent Files	Lists the recently used files in the configuration tool.	—
Exit	Terminates the configuration tool.	—
Edit		Reference
Delete Data Logging Setting	Deletes the data logging setting selected on the edit item tree.	Page 99, Section 8.2.4
Copy and Add Data Logging Setting	Copies the data logging setting selected on the edit item tree and adds it.	
Batch Data Insertion	Sets the setting items all at once.	
Cut Setting Item	Cuts the setting in the tabular form.	Page 101, Section 8.2.6
Copy Setting Item	Copies the setting in the tabular form.	
Paste Setting Item	Pastes the setting in the tabular form.	
Paste device copied in other application software	Pastes a device which is copied in other application into a line selected. (Existing data in the line are overwritten and erased.)	Page 119, Section 8.4.6
Insert Copied Setting Item	Pastes the copied setting in the tabular form.	Page 101, Section 8.2.6
Insert device copied in other application software	Pastes a device which is copied in other application into a line selected and shifts down existing data in the selected line and below.	Page 119, Section 8.4.6
Insert Cut Setting Item	Pastes the cut setting in the tabular form.	Page 101, Section 8.2.6
Delete Setting Item	Deletes the setting in the tabular form.	
Move Setting Item Upward	Moves the setting item upward.	
Move Setting Item Downward	Moves the setting item downward.	Page 102, Section 8.2.7
Device Batch Replacement	Replaces all of the configured devices.	
View		Reference
Switch Display Language	Changes the display language from the menu bar.	Page 47, Section 5.4
Online		Reference
Transfer Setup	Performs communication setting for connection to a CPU module.	Page 136, Section 8.6
Read Logging Setting	Reads the setting from the CPU module.	Page 143, Section 8.7
Write Logging Setting	Writes the setting to the CPU module.	Page 145, Section 8.8
Delete Logging Setting	Deletes the setting in the CPU module.	Page 145, Section 8.8
Logging Status and Operation	Checks the logging status.	Page 147, Section 8.9
Logging File Operation	Accesses the CPU module, and downloads or deletes a file in the SD memory card installed in the CPU module.	Page 149, Section 8.10
Data Logging File Transfer Status	Displays transfer status of data logging files.	Page 154, Section 8.12
Tool		Reference
Start GX LogViewer	Starts GX LogViewer.	Page 47, Section 5.3
Help		Reference
Open Manual	Starts e-Manual Viewer, and opens the manual.	Page 156, Section 8.13.1
About Configuration tool	Displays the product information of the configuration tool.	Page 156, Section 8.13.2

8.2.3 Toolbar structure

The toolbar structure of the configuration tool is as listed below.

Icon	Equivalent menu item	Reference
	[Project] → [New]	Page 103, Section 8.3.1
	[Project] → [Open]	Page 103, Section 8.3.2
	[Project] → [Save]	Page 104, Section 8.3.3
	[Edit] → [Delete Data Logging Setting]	Page 99, Section 8.2.4
	[Edit] → [Cut Setting Item]	Page 101, Section 8.2.6
	[Edit] → [Copy Setting Item]	
	[Edit] → [Paste Setting Item]	
	[Online] → [Write Logging Setting]	Page 145, Section 8.8
	[Online] → [Read Logging Setting]	Page 143, Section 8.7
	[Online] → [Logging Status and Operation]	Page 149, Section 8.10
	[Online] → [Logging File Operation]	Page 152, Section 8.11

8.2.4 Edit item tree

The edit item tree is a tree that presents an overall view of the project setting.

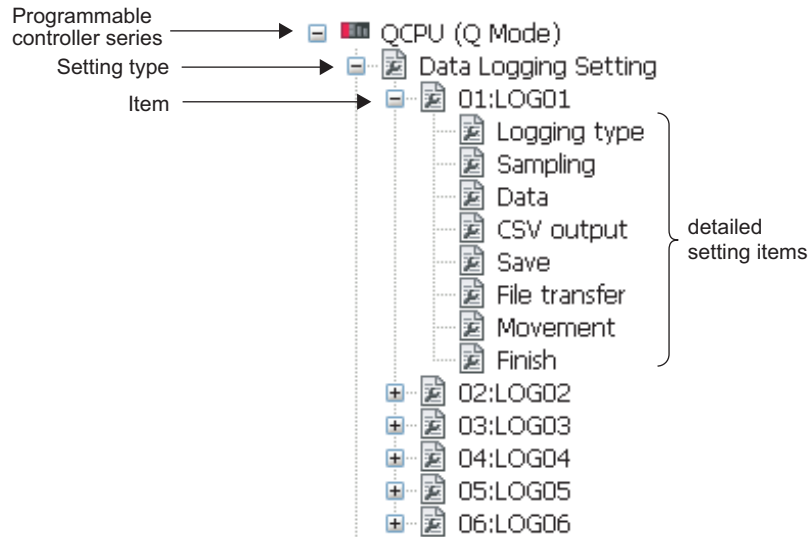

The following operations can be performed with the edit item tree.

(1) Editing a setting item

Selecting an item will display detail items. Selecting a detail item will display the corresponding setting window.

(2) Deleting a setting item

Selecting the item to be deleted, and then [Delete Data Logging Setting] from the [Edit] menu will delete the setting item.

(3) Copying and adding a setting item

Selecting the item to be copied, and then [Copy and Add Data Logging Setting] from the [Edit] menu will add the copied setting item.

8.2.5 Status bar

The following items are displayed on the status bar.

(1) Displayed window

The color of the left end of the status bar varies depending on the programmable controller series.

- High-speed Universal model QCPU, Universal model Process CPU: Light blue



- LCPU: Pink



(2) Displayed items

Name	Description
Connection route	The route for connecting to the CPU module is displayed. (The route set in the "Transfer Setup" window is displayed.) The route will be displayed during operation of the configuration tool until another route is specified.
No. of data logging settings	The number of data logging settings is indicated.

8.2.6 Common operations

(1) Adjusting a column width

In a table in the advanced settings area of the configuration tool, drag the right boundary of the column as illustrated below.

No.	Data Logging Name	Logging Type	Sampling
01	Data Logging Setting No.1	Continuous	Each scanning cycle
02	Data Logging Setting No.2	Continuous	Each scanning cycle

(2) Displaying a tooltip

In a table in the advanced settings area of the configuration tool, when the mouse pointer is placed on a cell, a tooltip appears and displays the entire information in the cell. It is useful for checking an item name that is too long to be fully displayed in the standard format.

No.	Data Logging Name	Logging Type
01	Data Logging Setting No.1	Continuous
02	Data Logging Setting No.2	Continuous
03	Data Logging Setting No.3	Trigger

(3) Cutting, copying, or pasting a setting item

In a table in the advanced settings area of the configuration tool, data can be cut, copied, and pasted in units of cells or lines. Select cell(s) or line(s) (highlighted in blue), and perform the following.

 [Edit] ⇒ [Cut Setting Item] or [Edit] ⇒ [Copy Setting Item] or [Edit] ⇒ [Paste Setting Item]

These operations are also available by selecting "Cut setting item", "Copy setting item", or "Paste setting item" from the right-click menu.

No.	Data Logging Name	Logging Type	Sampling
01	Data Logging Setting No.1	Continuous	Each scanning cycle
02	Data Logging Setting No.2	Continuous	Each scanning cycle
03			
04			
05			
06			
07			
08			
09			
10			

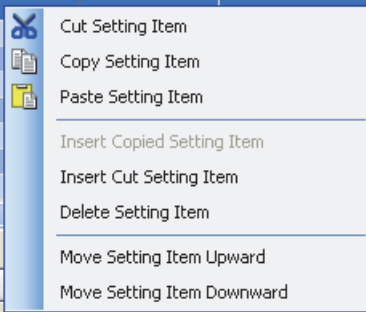

8.2.7 Device batch replacement

Devices can be replaced with others all at once in the entire project in the data logging setting.

(1) Operating procedure

1. Display the "Device Batch Replacement" window.

 [Edit] ⇒ [Device Batch Replacement]

2. Enter data.

3. Click the  button.

(2) Setting window

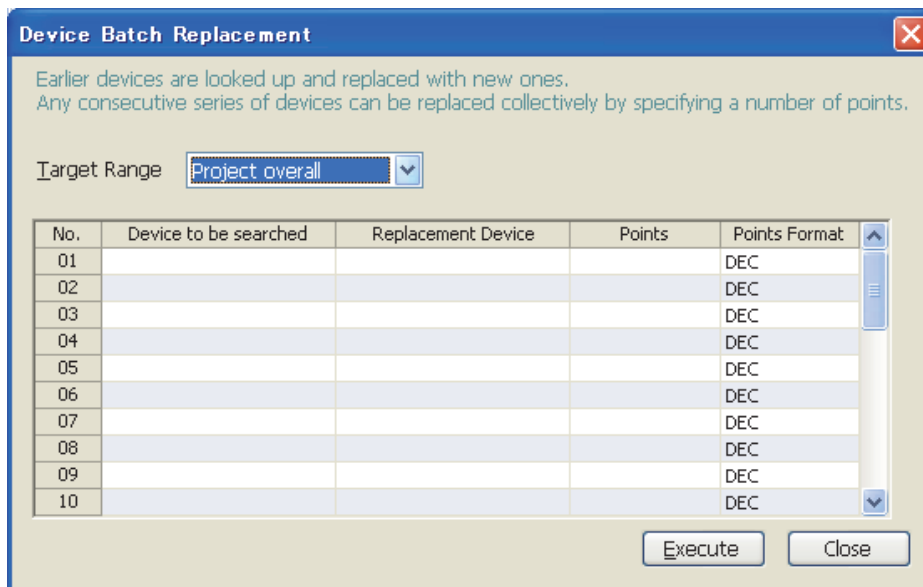

Device Batch Replacement

Earlier devices are looked up and replaced with new ones.
Any consecutive series of devices can be replaced collectively by specifying a number of points.

Target Range

No.	Device to be searched	Replacement Device	Points	Points Format
01				DEC
02				DEC
03				DEC
04				DEC
05				DEC
06				DEC
07				DEC
08				DEC
09				DEC
10				DEC

(3) Setting items and button

Item	Description
Target Range	Specify the target range of the devices to be replaced.
Device to be searched	Specify the head device of the devices to be replaced.*1
Replacement Device	Specify the head device of the devices to be set after replacement.*1
Points	Specify the number of points for the devices to be replaced.
Points Format	Select a display format of the points. (Decimal or hexadecimal)
 button	Executes the device batch replacement.

*1 Devices that can be set for "Sampling", "Data", and "Trigger" in the data logging setting can be specified.

8.3 Project Management

This section describes the project management.

8.3.1 Creating a new project

A new project can be created by the following operation.

 [Project] ⇒ [New]

8.3.2 Opening a project

A saved project can be read.

(1) Operating procedure

1. Open the "Open" window.

 [Project] ⇒ [Open]

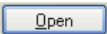
2. Select a file name, and click the  button.

(2) Setting window

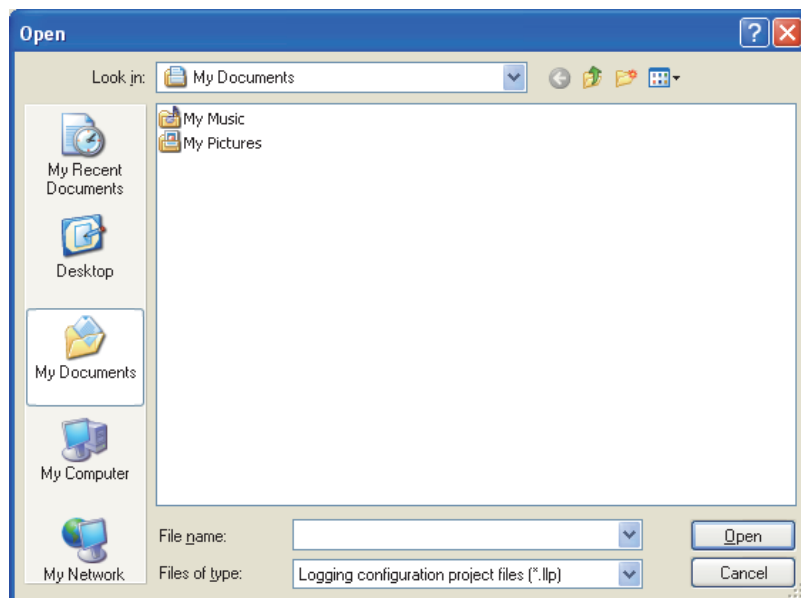

(3) Setting items

Item	Description
Look in	Select a folder in which the project file is stored.
File name	Specify the project file name.
Files of type	Select a project file type (extension).

8.3.3 Saving a project

Save the currently editing settings to a project file.

(1) When saving the file

(a) Operating procedure

Perform the following.

 [Project] ⇒ [Save]

(2) When saving the file with a new name

(a) Operating procedure

1. Open the "Save as" window.

 [Project] ⇒ [Save as]

2. Specify the file name, and click the  button.

(b) Setting window

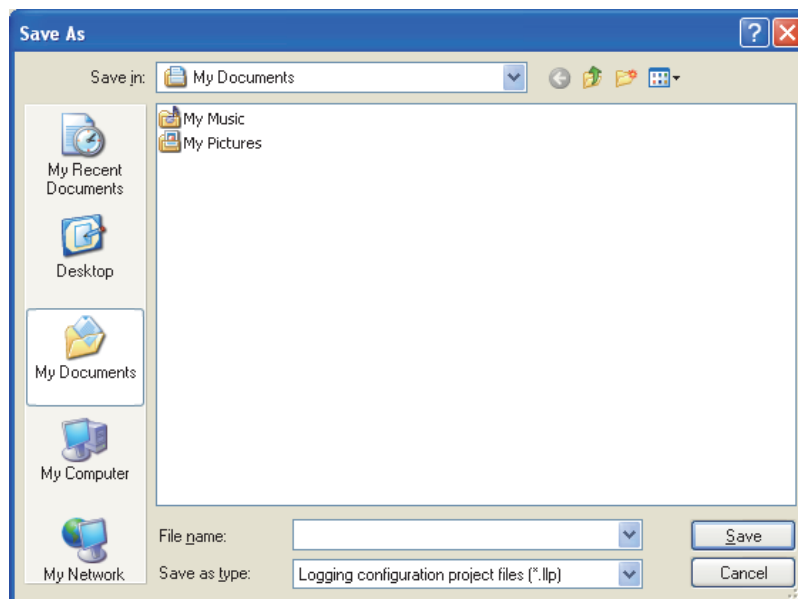

(c) Setting items

Item	Description
Save in	Select a folder in which the project file is to be stored.
File name	Specify the project file name.
Save as type	Select a type (extension) of the project file to be stored.

8.3.4 Changing a programmable controller series

Change the programmable controller series of the project being edited.

(1) Operating procedure

1. Open the "Change PLC series" window.

 [Project] ⇒ [Change PLC series]

2. Select the programmable controller series, and click the  button.

(2) Setting window

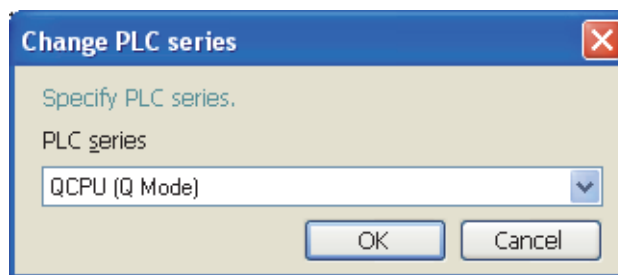

(3) Setting item

Item	Description
PLC series	Select "QCPU (Q Mode)" for the High-speed Universal model QCPU and Universal model Process CPU, "LCPU" for the LCPU, and "RCPU" for the RCPU.

8.3.5 Reading the data logging setting from the SD memory card

Read the data logging setting written on the SD memory card in the personal computer.

(1) Operating procedure

1. Install the SD memory card in the personal computer.
2. Open the "Read Logging Setting from Memory Card(SD)" window.

 [Project] ⇒ [Read Logging Setting from Memory Card(SD)]

3. Select a drive to read from.
4. Select a setting item to read.
5. Click the  button.

Point

- If some data currently exist in the configuration tool before reading, the common settings and the setting data with the same setting No. will be overwritten. Data other than the above will be held in the configuration tool. Because of this, the data to be read out may not match the data read out.
 - If the programmable controller series of the setting data differs between in the SD memory card and in the configuration tool, the one in the SD memory card is replaced with that in the configuration tool when the setting data is read. Note that the setting data cannot be read if its programmable controller series in the SD memory card is "RCPU" or "FX5CPU".
-

(2) Setting window

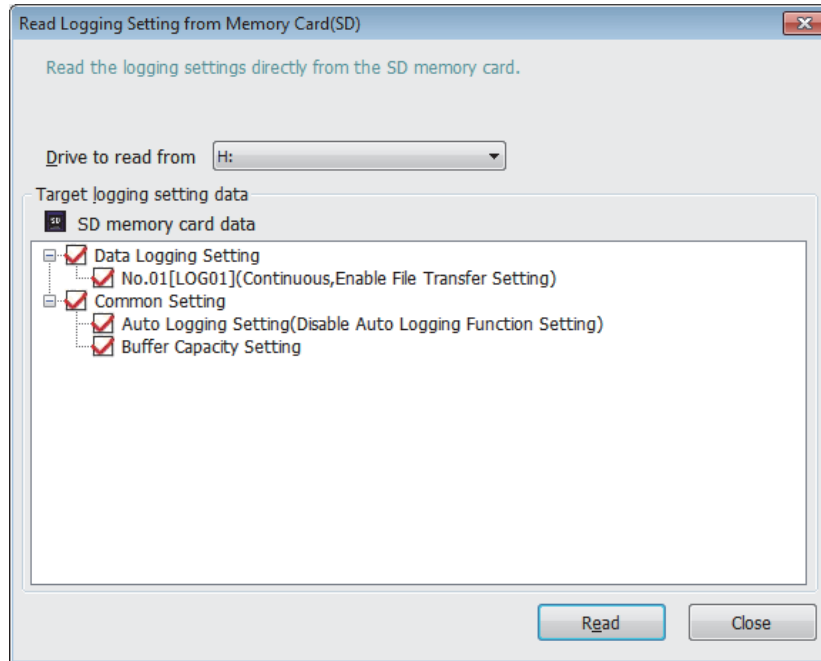

(3) Setting items

Item	Description
Drive to read from	A list of the drives recognized by the personal computer is displayed.
Target logging setting data	A list of the data that have been written to the SD memory card is displayed. (Data Logging Setting and Common Setting are listed.)

8.3.6 Writing the data logging setting to the SD memory card

Write the currently editing data in a form available for CPU module operation. Data are written directly to the SD memory card in the personal computer. When the SD memory card is installed into the CPU module, logging is started.

(1) Operating procedure

1. Install the SD memory card in the personal computer.
2. Open the "Write Logging Setting into Memory Card(SD)" window.

 [Project] ⇒ [Write Logging Setting into Memory Card(SD)]

3. Select a drive to write into.
4. Select a setting item to write.
5. Click the  button.

Point

If some data currently exist in the SD memory card before writing, the common settings and the setting data with the same setting No. will be overwritten. Data other than the above will be held in the SD memory card. Because of this, the data to be written may not match the data written.

(2) Setting window

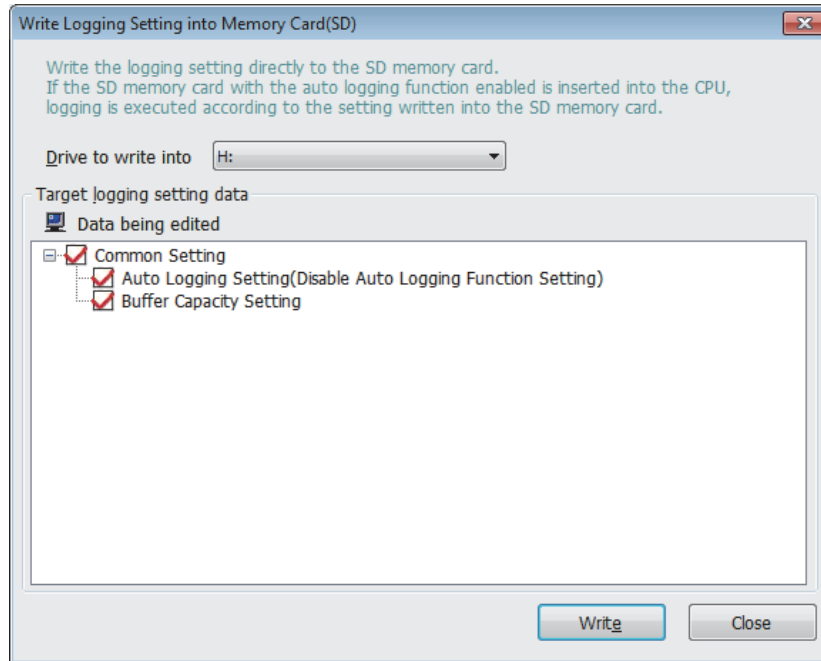

(3) Setting items

Item	Description
Drive to write into	A list of the drives in the personal computer is displayed.
Target logging setting data	A list of the data that are currently set is displayed. (Data Logging Setting and Common Setting are listed.)

8.4 Data Logging Setting

Configure the settings required for data logging. For the specifications of data logging, refer to  Page 34, CHAPTER 3.

8.4.1 Data logging setting list

This section describes the items in the data logging setting list.

(1) Operating procedure

Perform the following.

 [Data logging setting] on the edit item tree

(2) Setting window

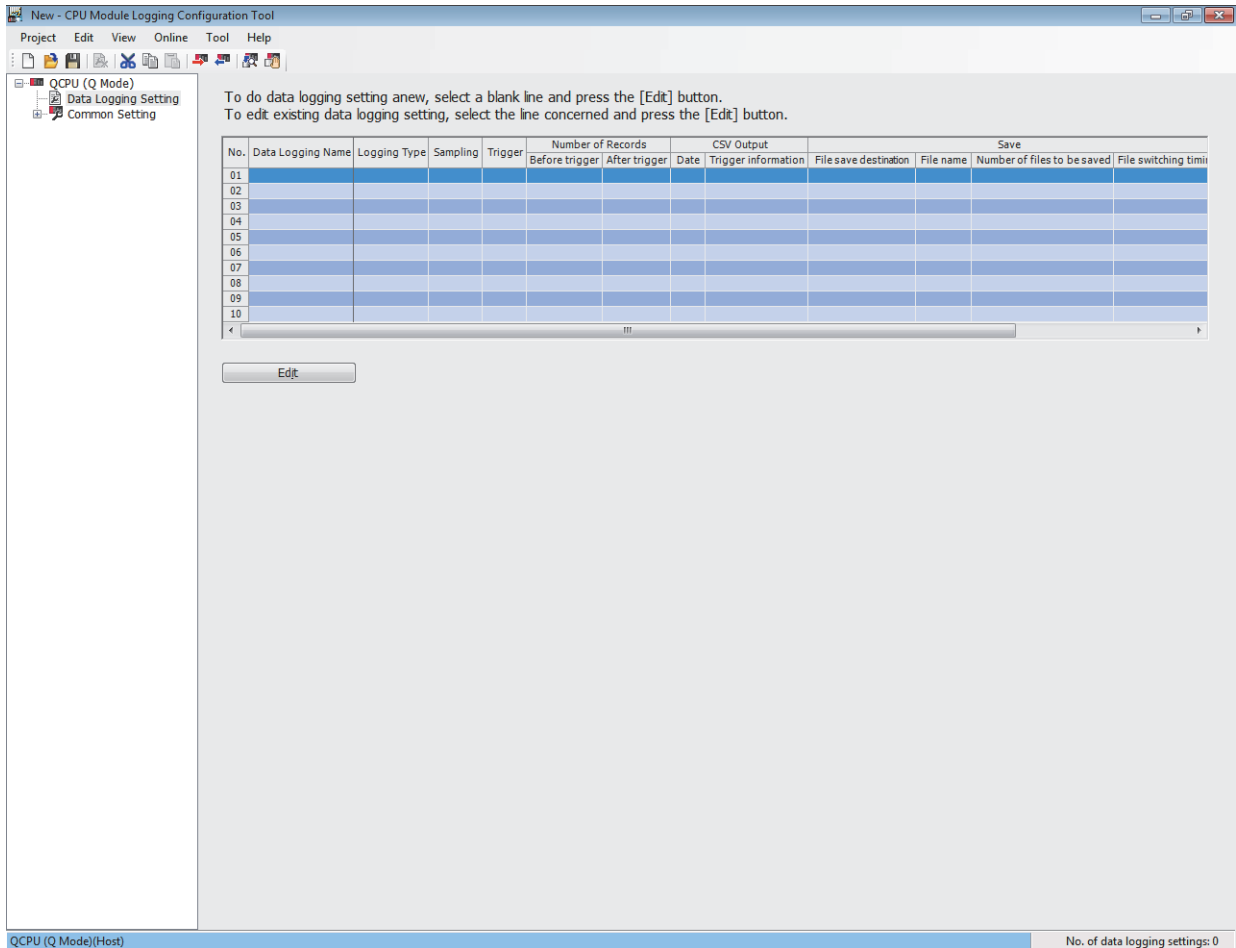

(3) Displayed items and button

Item		Description	Setting	Reference
No.		The data logging setting No. is displayed.	01 to 10	—
Data Logging Name		The data logging name is displayed.	Any name (32 one-byte or 16 two-byte characters)	—
Logging Type		The logging type is displayed.	Continuous logging/Trigger logging/Specification period logging	Page 114, Section 8.4.3
Sampling		The target data sampling interval of the data logging is displayed.	Each scanning cycle/Time specification/ Multiple CPU/Condition specification	Page 115, Section 8.4.4
Trigger		The triggering condition is displayed.	Condition/Trigger instruction execution/Data logging trigger operation	Page 121, Section 8.4.8
Specification period		The conditions of the data sampling period are displayed.	Condition specification	Page 123, Section 8.4.9
Number of Records	Before trigger	The number of logging records before trigger is displayed.	0 to 999999	Page 124, Section 8.4.10
	After trigger	The number of logging records after trigger is displayed.	1 to 1000000	
CSV Output	Date	Whether the date and time (time stamp) is output or not is shown.	To be outputted/Not to be outputted	Page 125, Section 8.4.11
	Trigger information	Whether trigger information exists or not is shown.	To be outputted/Not to be outputted	
Save	File save destination	The destination to save is displayed.	Simple setting/Option setting	Page 127, Section 8.4.12
	File name	The saved file name after switching is displayed.	Folder name, date, and time	
	Number of files to be saved	The upper limit in the number of files is displayed.	1 to 65535	
	File switching timing	The data logging file switching timing is displayed.	No. of records, file size condition/Trigger logging	
File Transfer		Whether the data logging file transfer function is enabled or disabled is displayed.	Transfer/Not transfer	Page 129, Section 8.4.13
Movement		The data logging setting in the case of transition to RUN is displayed.	Auto Start/ Start by User Operation	Page 131, Section 8.4.14
Log Total[MB]		The total size of the logging files output for each logging setting is displayed.	—	Page 132, Section 8.4.15
 button		Displays the data logging setting area, allowing editing of the setting for the selected line. When a blank line is selected, a new data logging setting is added. (If multiple lines are selected, they will be masked.)		Page 110, Section 8.4.1

Point

- The operations do not depend on the order of the data logging settings.
- By clicking multiple lines while pressing the **Ctrl** or **Shift** key, these lines can be deleted or replaced all at once.



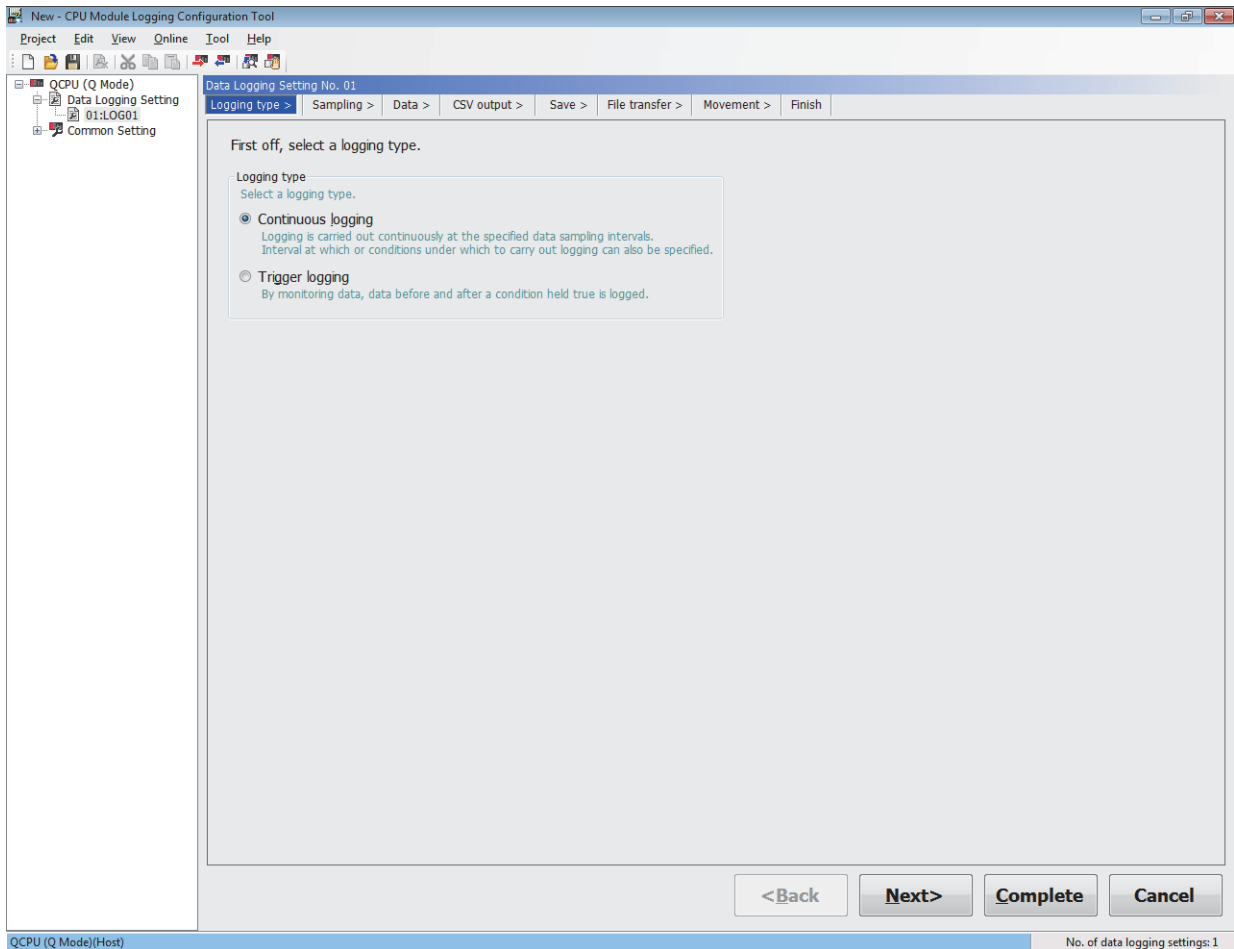

8.4.2 Change of the data logging setting window

The data logging setting can be performed by following the wizard. The title of each wizard window is displayed on the bar located on the top of the advanced settings area. Configure the settings, moving in order from the left tab to the right tab on the bar.

(1) Setting window



(2) Operation buttons

Button	Description
 button	Makes the current setting wizard window return to the previous window (to the left).
 button	Changes the current setting wizard window to the next window (to the right).
 button	Determines the current data logging setting, and terminates the editing. The display returns to the data logging setting list window.
 button	Cancels the current data logging setting, and terminates the editing. After cancellation, the display returns to the data logging setting list window.

(3) Display and operation of the wizard

(a) Changing the window with the <Back and Next> buttons

The window can be switched as illustrated below.

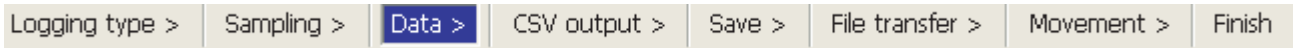

(b) Edit items in data logging setting

○: Setting required, —: No setting item

Setting item	Continuous logging	Trigger logging	Reference
Logging type	○	○	Page 114, Section 8.4.3
Sampling	○	○	Page 115, Section 8.4.4
Data	○	○	Page 117, Section 8.4.5
Trigger	—	○	Page 121, Section 8.4.8
Number of logging lines	—	○	Page 124, Section 8.4.10
CSV output	○	○	Page 125, Section 8.4.11
Save	○	○	Page 127, Section 8.4.12
File transfer	○	○	Page 129, Section 8.4.13
Movement	○	○	Page 131, Section 8.4.14
Finish	○	○	Page 132, Section 8.4.15

8.4.3 Logging type

Select a logging type. (☞ Page 56, Section 6.3)

(1) Setting window

First off, select a logging type.

Logging type
Select a logging type.

Continuous logging
Logging is carried out continuously at the specified data sampling intervals.
Interval at which or conditions under which to carry out logging can also be specified.

Trigger logging
By monitoring data, data before and after a condition held true is logged.

Specification period logging
Data will be logged when specified condition is met.

File format
Output data by CSV format in QCPU/LCPU.
The data can be checked not only by GX LogViewer but also by text editor or table calculation soft.

(2) Setting items

	Item	Description	Setting range
Logging type	Continuous logging	Select this when performing continuous logging.	—
	Trigger logging	Select this when performing trigger logging.	—
	Specification period logging ^{*1}	Select this when performing specification period logging.	—

^{*1} Only the High-speed Universal model QCPU and the Universal model Process CPU support this item. Before using the specification period logging, check the versions of the CPU module and configuration tool used. (☞ Page 190, Appendix 2)

8.4.4 Sampling

Select a sampling method and specify the sampling interval. (☞ Page 50, Section 6.2)

(1) Setting window

Specify the sampling interval and start conditions.

Sampling interval

Each scanning cycle
Samples data at each sequence scanning cycle.

Time specification
Samples data at the specified time interval.
 Sample data at the next END processing after the specified time has elapsed(W)

Each multiple CPU high speed transmission cycle x 0.88[ms] (1-50)
Sample data by multiple interval of multiple CPU high speed transmission cycle (0.88ms).

Condition specification
Specifies data sampling timing by device data conditions or step No.
If both "device specification" and "step No. specification" are selected, data will be sampled when both conditions are met.

Device specification(J)
Device Conditional formula Radix Value

Step No. specification
Samples data when the status immediately before execution of the specified step satisfies the specified execution conditions.
Program name Step No. Execution condition

(2) Setting items

Item		Description	Setting range		
Sampling interval	Each scanning cycle		Select this when data are to be sampled at each scanning cycle.	—	
	Time specification	Time value	Set a sampling interval value.	<ul style="list-style-type: none"> • Millisecond: 1 to 32767 • Second: 1 to 86400 	
		Unit of time	Select a unit of time.	ms or s	
		Sample data at the first END processing after the specified time has elapsed	Select this when data are to be sampled in the first END processing after the specified time has elapsed.	—	
	Each multiple CPU high speed transmission cycle ^{*1}		Specify a data sampling cycle. Data are sampled at the interval obtained by multiplying the specified cycle by 0.88ms (multiple CPU high speed transmission cycle).	1 to 50	
	Condition specification	Device specification	Device	Any of the devices listed in Page 52, Section 6.2 (4) (a) can be set.	—
			Conditional formula	<ul style="list-style-type: none"> • For bit device "PLS": When the bit of the bit device rises Data are sampled when the status of the specified device is changed from off to on. "PLF": When the bit of the bit device falls Data are sampled when the status of the specified device is changed from on to off. • For word device "=": When the word device value meets the specified value Data are sampled when the current value of the specified device is equal to the condition value. "During change": When the word device data is changed Data are sampled when the current value of the specified device is changed. 	<ul style="list-style-type: none"> • For bit device: "PLS", "PLF" • For word device: "=", "During change"
			Radix	Set a radix of the condition value for the word device.	DEC or HEX
			Value	Set a value that is compared with a device value.	<ul style="list-style-type: none"> • Decimal: -32768 to 32767 • Hexadecimal: 0_H to FFFF_H
		Step No. specification	Program name	Enter a name of the program in which data are sampled when the condition is met in the specified step.	Eight alphanumeric characters or less
			Step No.	Set a step number of the step where data are to be sampled when the condition is met.	0 to 266240
			Execution condition	Select a data sampling condition from the following. "Always": Always Data are always sampled in the specified step. "ON": When execution condition is ON Data are sampled when the result of the operation in the specified step is true. "OFF": When execution condition is OFF Data are sampled when the result of the operation in the specified step is false. "PLS": When execution condition rises Data are sampled at the time the result of the operation in the specified step is changed from false to true. "PLF": When execution condition falls Data are sampled at the time the result of the operation in the specified step is changed from true to false.	"Always", "ON", "OFF", "PLS", "PLF"

*1 Only the High-speed Universal model QCPU and the Universal model Process CPU support this item.

8.4.5 Data

Set sampled device data, such as data type. (☞ Page 49, Section 6.1)

Point

- To paste a device which is copied in other application (such as Watch window of GX Works3 or GX Works2, a spreadsheet, or a text editor), use "Paste device copied in other application software" or "Insert device copied in other application software". (☞ Page 119, Section 8.4.6)
- To insert a block of data into the data list all at once, use "Batch Data Insertion". (☞ Page 120, Section 8.4.7)

(1) Setting window

Set the data for logging.
 A total of up to 128 device points can be set.
 Bit digit specification is using points corresponding to data type. (1 point for word type and 2 points for double-word type)

No.	Head	Device	Last	Data Type	Size [Byte]	Output Format
001						
002						
003						
004						
005						
006						
007						
008						
009						
010						
011						
012						
013						
014						
015						
016						
017						
018						
019						
020						
021						
022						
023						
024						
025						
026						
027						
028						
029						
030						
031						
032						
033						
034						
035						
036						
037						
038						
039						
040						
041						
042						
043						

(2) Setting items

Item		Description	Setting range
No.		Data setting numbers, 001 to 128 are displayed.	—
Device	Head	Specify the head device number.	—
	Last	The last device number calculated from the data type and size is displayed.	—
Data Type	Select a data type of the target data.		<ul style="list-style-type: none"> • Bit • Word [signed] • Double word [signed] • Word [unsigned] • Double word [unsigned] • Float [single precision] • Float [double precision] • String • Raw
Size [Byte]	Specify the size when the data type is "String" or "Raw".		1 to 256 bytes
Output Format	Clicking the  button on the right end of each line displays the "Output format (integer/float)" window. Select the type of the format for data output to files.		<ul style="list-style-type: none"> • Decimal format • Hexadecimal format • Exponential format (Number of digits: 0 to 14)

8.4.6 Paste/Insert device copied in other application software

A device which is copied in other application (such as Watch window of GX Works3 or GX Works2, a spreadsheet, or a text editor) can be paste to any line in the setting window of "Data".

Remark

Before using these functions, check the version of the configuration tool used. (Page 190, Appendix 2)

(1) Operating procedure

On the setting window of "Data", select a line where copied data is to be pasted and select the item in the right-click menu.

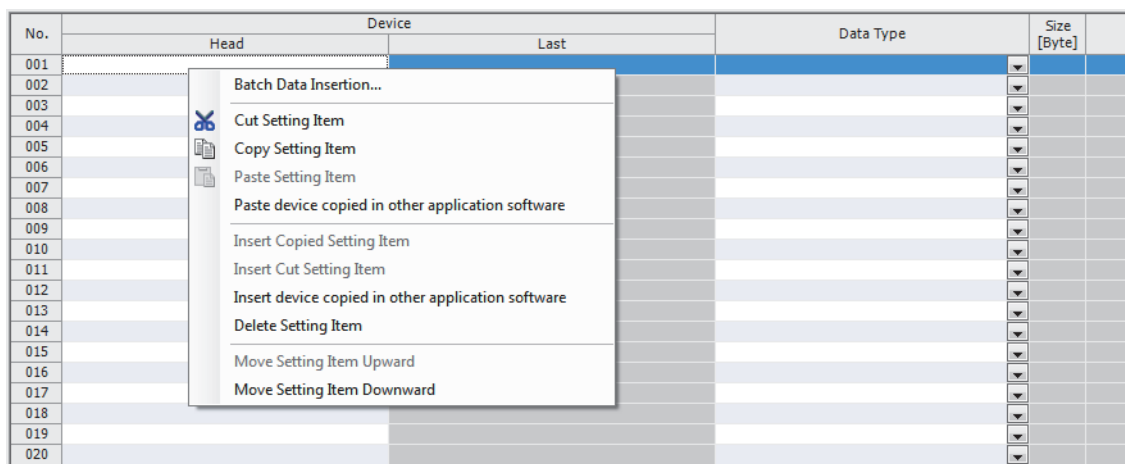

Point

The keyboard shortcut for "Paste device copied in other application software" is **Ctrl** + **Shift** + **V**. Note that this keyboard shortcut is valid only when the head device column is selected.

(2) Operation details

The following table summarizes the operation details of the functions.

Item	Operation
Paste device copied in other application software	Pastes a device which is copied in other application into a line selected. (Existing data in the line are overwritten and erased.) ^{*1*2} Settings other than head devices are entered as default settings correspond to each device.
Insert device copied in other application software	Pastes a device which is copied in other application into a line selected and shifts down existing data in the selected line and below. ^{*1*2} Settings other than head devices are entered as default settings correspond to each device.

*1 From the start to the newline or the first tab of strings in each line on the clipboard are pasted or inserted.

*2 If a copied string is invalid as a device, it cannot be pasted or inserted.

8.4.7 Batch data insertion

In the data list, a block of data can be inserted all at once. Data are entered in order from the highest numbered blank line on the "Data" setting window. (If there is a line where data has already been set, the line will be skipped.)

(1) Operating procedure

In the right-click menu on the "Data" setting window, select "Batch Data Insertion".

(2) Setting window

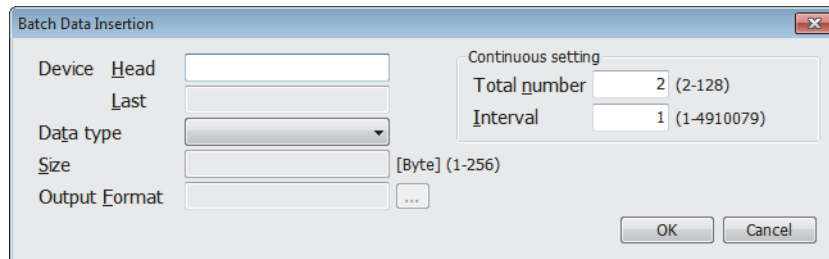

(3) Setting items

Item	Description	Setting range	
Device	Head	Specify the head device number.	—
	Last	The last device number calculated from the data type and size is displayed.	—
Data type	Select a data type of the target data.	<ul style="list-style-type: none"> • Bit • Word [signed] • Double word [signed] • Word [unsigned] • Double word [unsigned] • Float [single precision] • Float [double precision] • String • Raw 	
Size	Specify the size when the data type is "String" or "Raw".	1 to 256 bytes	
Output Format	Clicking the  button on the right of "Output Format" displays the "Output format (integer/float)" window. Select the type of the format for data output to files.	<ul style="list-style-type: none"> • Decimal format • Hexadecimal format • Exponential format (Number of digits: 0 to 14) 	
Continuous setting	Total number	Specify the total number of data to be entered all at once.	2 to 128 points
	Interval	Specify the interval of the data to be entered all at once.	<ul style="list-style-type: none"> • QnUDVCP, QnUDPVCP: 1 to 4910079 points • LCP: 1 to 421887 points

8.4.8 Trigger

If "Trigger logging" is selected for Logging type, specify the trigger condition. (☞ Page 59, Section 6.3.2 (1))

(1) Setting window

Make trigger setting.

Condition specification
 Sets trigger condition with device data values and step No. If both "Device change specification" and "Step No. specification" are selected, an AND condition of each setting is required to be met.

Device change specification(J)

Device	Conditional formula	Radix	Value
<input type="text"/>	<input type="text"/>	<input type="text"/>	<input type="text"/>

Step No. specification
 Conditions met when the status immediately before execution of the specified step satisfies the specified execution conditions.

Target program name	Step No.	Execution condition
<input type="text"/>	<input type="text"/>	<input type="text"/>

When trigger instruction executed
 Trigger conditions met when LOGTRG instruction is executed.

When data logging trigger activated
 Trigger conditions met when the data logging trigger (SM device) of each setting No. turns on.

(2) Setting items

Item		Description	Setting range	
Condition specification	Device change specification	Device	Any of the devices listed in Page 59, Section 6.3.2 (1) (a) can be set.	—
		Conditional formula	<ul style="list-style-type: none"> For bit device "PLS": When the bit of the bit device rises A trigger occurs when the status of the specified device is changed from off to on. "PLF": When the bit of the bit device falls A trigger occurs when the status of the specified device is changed from on to off. For word device "=": When the word device value meets the specified value A trigger occurs when the data that match the specified value are written^{*1}, regardless of the current value status of the specified device (match or not match with the specified value). "Write": When data are written to a word device A trigger occurs when data are written^{*1} to the specified device. 	<ul style="list-style-type: none"> For bit device: "PLS", "PLF" For word device: "=", "Write"
		Radix	Set a radix of the condition value for the word device.	DEC or HEX
		Value	Set a condition value.	<ul style="list-style-type: none"> Decimal: -32768 to 32767 Hexadecimal: 0_H to FFFF_H
	Step No. specification	Target program name	Enter the program name of the specified step No.	Eight alphanumeric characters or less
		Step No.	Enter a step number of the step set as a trigger.	0 to 266240
		Execution condition	Set an execution condition.	"Always", "ON", "OFF", "PLS", "PLF"
	When trigger instruction executed		Select this to set a trigger to occur when the trigger logging set instruction in the program is executed.	—
	When data logging trigger activated		Select this to set a trigger to occur when the data logging trigger (SM device) corresponding to each data logging setting No. is turned on.	—

*1 A trigger will also occur in a case other than program execution (such as link refresh, transient update, or a device test conducted from a peripheral device).

8.4.9 Specification period

When "Specification period logging" is selected for Logging type, specify the conditions of the data sampling period.

(☞ Page 61, Section 6.3.3)

(1) Setting window

Specify period condition of specification period logging.

Specify period condition with device data values.
Data will be logged when specified condition is met.

Condition specification

Device	Conditional formula	Radix	Value
<input type="text"/>	<input type="text"/>	<input type="text"/>	<input type="text"/>

(2) Setting items

Item	Description	Setting range
Device	Any of the devices listed in Page 62, Section 6.3.3 (1) (b) can be set.	—
Condition specification	<ul style="list-style-type: none"> For bit device "ON": When the status of the specified device is on Data are sampled while the specified device is on. "OFF": When the status of the specified device is off Data are sampled while the specified device is off. For word device "=": When the current value of the specified device meets the condition value Data are sampled while the current value of the specified device is equal to the condition value. 	<ul style="list-style-type: none"> For bit device: "ON", "OFF" For word device: "="
Radix	Set a radix of the condition value for the word device.	DEC or HEX
Value	Set a condition value.	<ul style="list-style-type: none"> Decimal: -32768 to 32767 Hexadecimal: 0_H to FFFF_H

8.4.10 Number of logging lines

When "Trigger logging" is selected for Logging type, set the number of records to be output before and after occurrence of a trigger.

( Page 57, Section 6.3.2)

(1) Setting window

Data before and after trigger condition rises will be logged.
Specify the numbers of records before and after trigger.

No. of records (before trigger) Record (0-999999)

No. of records (after trigger) Record (1-1000000)

Total No. of records Record (1-1000000)

(2) Setting items

Item	Description	Setting range
No. of records (before trigger)	Set the number of records to be output as data before trigger.	0 to 999999
No. of records (after trigger)	Set the number of records to be logged after trigger (including the trigger).	1 to 1000000
Total No. of records	The total number of records before and after trigger is displayed.	—

8.4.11 CSV output





Set the details of CSV file output. (☞ Page 37, Section 3.3)

(1) Setting window

Set items to be output to a CSV file.

<p>Date Carry out the logging with a time stamp attached to data.</p> <p><input checked="" type="checkbox"/> Output date column <input type="button" value="Set Date Line Format..."/></p>	<p>Device comment output Outputs device comments instead of devices in the data column.</p> <p><input type="checkbox"/> Output device comments for data column</p> <p>Target memory <input type="text"/></p> <p>Target comment file name <input type="text"/></p>
<p>Trigger information Data line on which a trigger occurred is logged after attached with a mark.</p> <p><input checked="" type="checkbox"/> Output trigger information column <input type="button" value="Set String for Trigger..."/></p>	<p>Comment Outputs comments on the settings. The specified comment will be output at the top of the logging file.</p> <p><input checked="" type="checkbox"/> Output comments</p> <p>Comment(k) <input type="text" value="LOG01"/></p>
<p>Index Outputs index numbers for checking the continuity of logging in the direction of column.</p> <p><input checked="" type="checkbox"/> Output index column</p>	
<p>Data sampling interval Outputs data sampling interval time in the direction of column.</p> <p><input checked="" type="checkbox"/> Output data sampling interval column(j)</p>	
<p>Execution program name Outputs execution program name from which the data has been sampled in the direction of column.</p> <p><input checked="" type="checkbox"/> Output execution program name</p>	
<p>Execution step No. Outputs step numbers of which the data has been sampled in the direction of column.</p> <p><input checked="" type="checkbox"/> Output execution step No. column</p>	

(2) Setting items

Item		Description	Setting range
Date	Output date column  button	The "Date Line Output Format" window is displayed. Set the data line output format.*4*6 For available characters, refer to  Page 157, Section 8.14.	Up to 27 one-byte characters
Trigger information	Output trigger information column*1  button*5	The "String for Indicating Trigger Occurrence" window appears. Set a character string that is appended to the data line and indicates occurrence of a trigger. For available characters, refer to  Page 157, Section 8.14.	32 one-byte or 16 two-byte characters or less
Index	Output index column	Index numbers are output to files.	—
Data sampling interval	Output data sampling interval column	Information in the data sampling interval column is output to files.	—
Execution program name	Output execution program name	Information in the execution program name column is output to files.*2	—
Execution step No.	Output execution step No. column	Information in the execution step No. column is output to files.*3	—
Device comment output	Output device comments for data column	Target memory	<ul style="list-style-type: none"> • Program Memory • Standard ROM • SD memory card
		Target comment file name	Specify the comment file used for comment display. Eight alphanumeric characters or less
Comment	Output comments	Comment lines are output to CSV files.	—
	Comment*5	The comment is output at the beginning of the CSV file.	256 two-byte characters or less (no line feed)

*1 This setting is enabled only when "Trigger logging" is selected for Logging type.

*2 If the timing of sampling coincides with a system operation (such as a system interrupt), "*SYSTEM" is output.

*3 If the timing of sampling coincides with a system operation (such as a system interrupt), "0" is output.

*4 If any of "year", "month", "day", "hour", "minute", and "second" is missing, when the data logging file is opened by GX LogViewer, index data will be displayed instead of time data.

 GX LogViewer Version 1 Operating Manual

*5 The following characters cannot be entered. ( Page 158, Section 8.14.3)

- The input character is not supported as a character code of OS language.
- The language of the character code differs from that of the characters that have been entered to the data logging setting window.

*6 The "Data line output format" field can be set using the following format:

- Year: "YYYY" for four-digit notation and "YY" for two-digit notation
- Month: MM
- Day: DD
- Hour: hh
- Minute: mm
- Second: ss
- Millisecond: ms (3-digit notation or s, ss to ssssss, or sssssss (up to seven digits after the decimal point)

(Example) YY/MM/DD hh:mm:ss.sss → 10/10/13 09:44:35.241

8.4.12 Save

Set where to save the data logging files and when saved files are to be switched.

(☞ Page 64, Section 6.5.2)

(1) Setting window

Specify the save destination and switching timing of data logging files.

Logging file save setting
 Save destination in the SD memory card
 Specify the logging file save directory (folder name).
 Data will be stored in the following folder:
 /LOGGING/ LOG01

File name
 Simple setting
 The following information can be added to the file name. Select the information.
 Folder name Date Time
 Optional setting
 The optional information set here can be added to the file name.
 Date and time can also be set. For details, refer to the manual.
 Format
 Example 00000001.CSV

File switching setting

Number of files to be saved
 Specify the maximum number of files to be saved.
 Number of files to be saved (1-65535)
 Operation when exceeds the number of files:
 Overwrite
 Files with lower numbers are deleted and logging continues.
 Stop
 Logging stops.

File switching timing
 Specify the file switching timing.
 Number of records [Records] (100-65500)
 A logging file is switched to the new one when the number of records exceeds the specified value.
 File size [KB] (10-16384)
 A logging file is switched to the new one when the file size exceeds the specified value.

(2) Setting items

Item			Description	Setting range
Logging file save setting	Save destination in the SD memory card		Specify the folder to which the data logging file is saved (folder name). The file name must be unique.	32 one-byte characters or less (no two-byte characters)
	File name	Simple setting	Folder name	The folder name set in "Save destination in the SD memory card" is added.
			Date	If specified, the date (YYYYMMDD) is added.
			Time	If specified, the time (hhmmss) is added.
Optional setting*2		Set an additional format. Also, an optional character string can be added to the additional format.	*3*4	
File switching setting	Number of files to be saved	Number of files to be saved		Specify the maximum number of saved files.
		Operation when exceeds the number of files	Overwrite	Files with lower numbers are deleted and logging continues.
	Stop		Data logging is stopped when the specified number of files is exceeded.	
	File switching timing*1	Number of records		Specify the timing of file switching with the number of records. The file is switched when the specified number of records is exceeded.
File size		Specify the timing of file switching with the file size. The file is switched when the specified file size is exceeded.		

*1 Files may be switched at any other than the specified timing. (☞ Page 65, Section 6.5.3 (1))

*2 Before using this setting, check the versions of the CPU module and configuration tool used. (☞ Page 190, Appendix 2)

*3 Up to 48 one-byte characters (including the extension and period) can be used for this setting. However, the number of settable characters decreases when:

- Transfer completion/non-completion file distinction indication is used. (Two one-byte characters decrease.)
- Double quotation marks (" ") are used to set up character strings. (The number of characters for double quotation marks (" ") used decreases.)
- Characters are added by the SP.LOGFILES instruction. (The number of characters added decreases.)

Also, English letters, figures and symbols other than special symbols below can be used.

(space), ", *, /, :, ;, <, >, ?, \, |, .

*4 Date and time can be added by using the following character strings with an optional format.

- Year: "YYYY" for four-digit notation and "YY" for two-digit notation
- Month: MM
- Day: DD
- Day of week: ddd (Sunday: Sun, Monday: Mon, Tuesday: Tue, Wednesday: Wed, Thursday: Thu, Friday: Fri, Saturday: Sat)
- Hour: hh
- Minute: mm
- Second: ss

Ex. For 9:30 and 15 seconds, Friday, July 5, 2013

YYYYMMDDdddhhmmss → 20130705Fri093015_00000001.csv

If the character string is used as is (not used above format), optional character strings can be added by surrounding the target character string with double quotation marks (" ").

Ex. When "address" is added to the file name

"address" → address_00000001.csv

*5 If the set number or size is small and files are switched often, the scan time or service processing time or both may increase.

8.4.13 File transfer

Configure settings that are required for performing the data logging file transfer function. (☞ Page 82, Section 7.4)

(1) Setting window

Data logging files can be transferred to the FTP server.
Data logging files can be transferred to the specified FTP server at the file switching timing.

Transferring files to the FTP server
If the auto logging function is enabled, this function cannot be used.

Transfer Destination Server Setting List

No.	FTP Server	Login User Name	Password	Directory Path	Data Transfer Mode
01					
02					
03					
04					
05					
06					
07					
08					
09					
10					

*If the same directory path in the same transfer destination server is set to another CPU module, the transferred file may be overwritten.
Set the FTP server and directory path correctly.

FTP server connection request timeout time [s] (1-30)
Operation when file transfer is failed due to a network error

Resending files during the file transfer retry time
New files are repeatedly resent during the file transfer retry time.
If normal operation is restored after the file transfer retry time has passed, the transfer restarts from the newly created file.

File transfer retry time [m] (1-1440)

Resending files failed in transfer
Files failed in transfer are repeatedly resent until normal operation is restored.

Adding 'C_' at the beginning of a file name
'C_' is added at the beginning of the transferred file name so that the transferred file in the SD memory card can be identified.

(2) Setting items

Item	Description	Setting range
Transferring files to the FTP server	Set whether to enable or disable the data logging file transfer function.	—
<input type="button" value="Server Setting..."/> button	The "FTP Setting" window is displayed. (☞ Page 130, Section 8.4.13 (3))	—
Transfer Destination Server Setting List	Settings for the set transfer destination server are listed.	—
FTP server connection request timeout time	Set waiting time for the FTP server to respond to a connection request.	1 to 30 seconds
Resending files during the file transfer retry time	File transfer retry time If specified, the latest file is transferred repeatedly until the file transfer retry time is reached.	1 to 1440 minutes
Resending files failed in transfer*1	Specify when stack logging file transfer is executed. (☞ Page 92, Section 7.4.7)	—
Adding 'C_' at the beginning of the file name*1	Specify when transfer completion/non-completion file distinction indication is executed. (☞ Page 94, Section 7.4.8)	—

*1 Before using this setting, check the versions of the CPU module and configuration tool used. (☞ Page 190, Appendix 2)

The data logging file transfer function cannot be used while the auto logging function is enabled. Check that the auto logging function is disabled in advance.

(3) FTP setting

Set a transfer destination server.

(a) Setting window

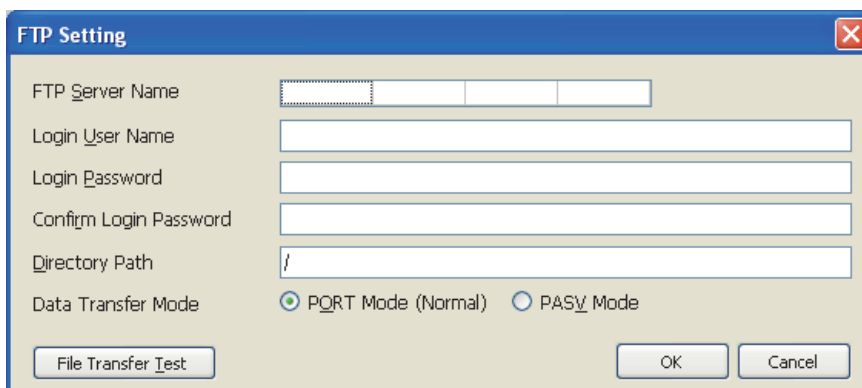

(b) Setting items

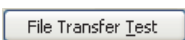
Item	Description	Setting range
FTP Server Name	Set the IP address of the transfer destination FTP server (decimal).	0.0.0.1 to 223.255.255.254
Login User Name	Set an FTP server account (user name).	1 to 32 ASCII characters (alphanumeric characters and special characters* ¹) A double quotation mark ("), comma (,), colon (:), and semicolon (;) cannot be used.
Login Password	Set a login password for the FTP server.	0 (blank) to 32 ASCII characters (alphanumeric characters and special characters* ¹)
Confirm Login Password		
Directory Path	Set a directory path on the transfer destination. (☞ Page 84, Section 7.4.2)	1 to 64 ASCII characters (alphanumeric characters and special characters* ¹) A double quotation mark ("), asterisk (*), comma (,), period (.), colon (:), semicolon (;), angle brackets (< >), question mark (?), and broken vertical bar () cannot be used.
Data Transfer Mode	Specify a data transfer mode of the FTP server. Set "PORT Mode (Normal)" usually. Due to a Windows firewall or other problems, if "PORT Mode (Normal)" cannot be set for communications between the CPU module and the FTP server, specify "PASV Mode".	<ul style="list-style-type: none"> • PORT Mode (Normal) • PASV Mode
 button	Whether the CPU module and the transfer destination server are normally connected or not is tested.* ¹	—

*¹ For file transfer test, "FTP Server Connection Request Timeout Time" is fixed to 10 seconds.

8.4.14 Movement

Specify the operation after the status is switched to RUN in the following cases. (☞ Page 77, Section 7.1)

- Power off → on
- Reset → RUN
- STOP → RUN

(1) Setting window

Specify logging operation.

Operation at transition to RUN

Specifies operation at transition to RUN in case that the PLC module power source is switched to RUN from ON or by reset operation, or the PLC module operation status is switched to RUN from STOP.

Auto Start

Start by User Operation

(2) Setting items

	Item	Description	Setting range
Operation at transition to RUN	Auto Start	Specify the operation at the time of status change, from power on to RUN, from reset to RUN, or from STOP to RUN, after registration of the data logging setting. Data logging is automatically started.	—
	Start by User Operation	Data logging is temporarily stopped. To restart the data logging, the user must perform a specific operation.	

8.4.15 Finish

Name the data logging and finish the setting.

(1) Setting window

All data required for data logging have been collected.
Press the "Complete" button to complete setting.

To reflect the settings to the PLC, select [Online]->[Write Logging Setting].

Name the data logging.

Data logging name

Free space volume below in SD memory card will be necessary to execute logging of the set content.
Larger volume might be necessary depending on status of SD memory card.



Total Size of Output Logging Files [MB]

To execute logging of the settings, the following buffer capacity is required.
Set buffer capacity as needed.

Required capacity [KB]

Currently set capacity [KB]

(2) Setting items

Item	Description	Setting range
Data logging name* ²	Specify a name for the current setting.	32 one-byte or 16 two-byte characters or less
Total Size of Output Logging Files* ¹	The total size of the logging files output for the setting is displayed. The total size can be adjusted with the items output to CSV files. Refer to the calculation formula shown in  Page 37, Section 3.3.2.	—
Required capacity	The buffer capacity required for the specified number of logging records is displayed. If the size of the current setting exceeds the buffer capacity, it is displayed in red. ( Page 68, Section 6.6)	—
Currently set capacity	The buffer capacity used by the currently editing project is displayed.	
<input type="button" value="Buffer Capacity Setting..."/> button	The "Buffer Capacity Setting" window appears. Set a buffer capacity for settings No.1 to No.10.	32 to 4832K bytes

*1 The file size stored to the SD memory card differs according to the SD memory card capacity. If the SD memory card capacity is 1GB or less, the file size may differ between the displayed size and the actual size.

*2 The following characters cannot be entered. ( Page 158, Section 8.14.3)

- The input character is not supported as a character code of OS language.
- The language of the character code differs from that of the characters that have been entered to the data logging setting window.

8.5 Common Setting

Initial settings for using the data logging function are configured. Clicking "Common Setting" on the edit item tree will display the area for the common setting.

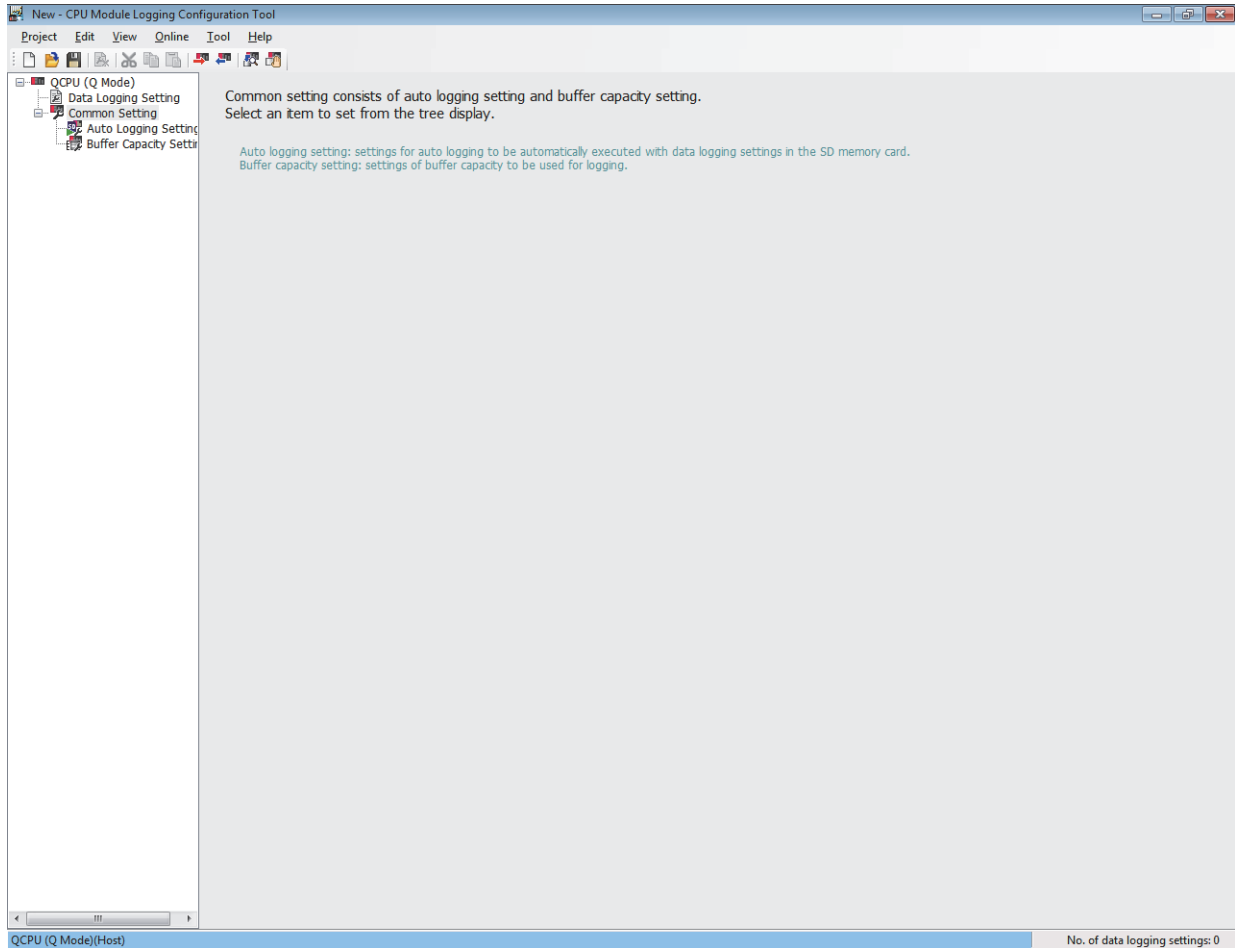

Common setting consists of the following settings.

Item	Description	Reference
Auto Logging Setting	Configure the settings that are required for the auto logging function.	Page 134, Section 8.5.1
Buffer Capacity Setting	A buffer size used for data logging is assigned to each setting number.	Page 135, Section 8.5.2

8.5.1 Auto logging setting

Configure the settings to perform the auto logging ( Page 78, Section 7.2) by inserting an SD memory card.

(1) Operating procedure

Perform the following.

 [Common Setting] on the edit item tree ⇒ [Auto Logging Setting]

(2) Setting window

Set for auto logging function.

Enable the auto logging function
 Inserting an SD memory card into the LCPU in RUN state causes the operation to start. Save the target data logging settings on the SD memory card before inserting.

Auto logging function will not operate by logging settings in the standard ROM. Logging being operated when the SD memory card is inserted will stop.

Auto logging terminate condition
 Specify conditions for terminating auto logging.
 If two or more conditions are selected, logging will terminate when any of the conditions is met.

Data logging stop
 Select when to terminate auto logging operation.

When all data loggings stop
 When any of the data loggings stops

Timer
 Complete with timer
 Terminates logging after a specified period of time has elapsed after logging starts.
 Elapsed time [s] (1-86400)

(3) Setting items

Item		Description	Setting range
Enable the auto logging function		For auto logging using an SD memory card, select this.	—
Auto logging terminate condition	Data logging stop	Set a condition to terminate auto logging.	<ul style="list-style-type: none"> • When all data loggings stop • When any of the data loggings stops
	Timer	Elapsed time	Set whether or not to terminate the auto logging after the specified period of time has elapsed after start of data logging. Set a time value for auto logging termination when "Complete with timer" is selected.
			1 to 86400 seconds

8.5.2 Buffer capacity setting

Set buffer capacity that can be used for each setting number. (☞ Page 68, Section 6.6)

(1) Operating procedure

Perform the following.

 [Common Setting] on the edit item tree ⇒ [Buffer Capacity Setting]

(2) Setting window

Set buffer capacity usable for each logging.

Setting No.	Buffer Capacity [KB]
01	128
02	128
03	128
04	128
05	128
06	128
07	128
08	128
09	128
10	128
Total	1280

Each buffer size can be set within the range of 32KB and 4832KB, with an increment of 1KB. A total of up to 5120KB can be set.

With larger capacity, an increased number of data can be sampled at trigger logging, and the possibility of the processing limits being exceeded can be lowered at continuous logging.

(3) Setting items

Item	Description	Setting range
Setting No.	Data logging setting numbers are displayed.	—
Buffer Capacity	Set the capacity of the buffer used.	32 to 4832K bytes
Total	The total of the configured buffer capacities is displayed.	—

Point

- Write the buffer capacity setting to the CPU module with all data loggings stopped. The data logging status can be confirmed in the "Logging Status and Operation" window. (☞ Page 149, Section 8.10)
- When executing the data logging function and the real-time monitor function concurrently, adjust the sum of the buffer capacity used in each function to not more than 5120K bytes. For how to set the buffer capacity of the real-time monitor function, refer to the following:

 GX LogViewer Version 1 Operating Manual

8.6 Transfer Setup

After starting the configuration tool, set a communication route for the CPU module and personal computer. Open the "Transfer Setup" window.

 [Online] ⇒ [Transfer Setup]

There are two connection methods:

- Direct connection with a USB or Ethernet cable
- Connection via a network

8.6.1 Connection with a USB or Ethernet cable

The following explains the window operation.

(1) Operating procedure

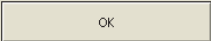
1. Click the  button in the "Transfer Setup" window.
2. Select "USB" or "Ethernet" in the "PLC Direct Connection Setting" window, and click the  button.
3. Click the  button in the "Transfer Setup" window.

(2) Setting window

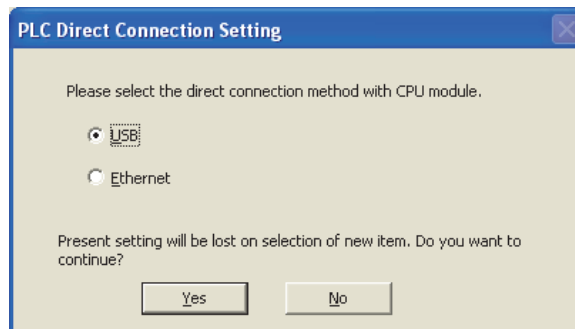

(a) "PLC Direct Connection Setting" window

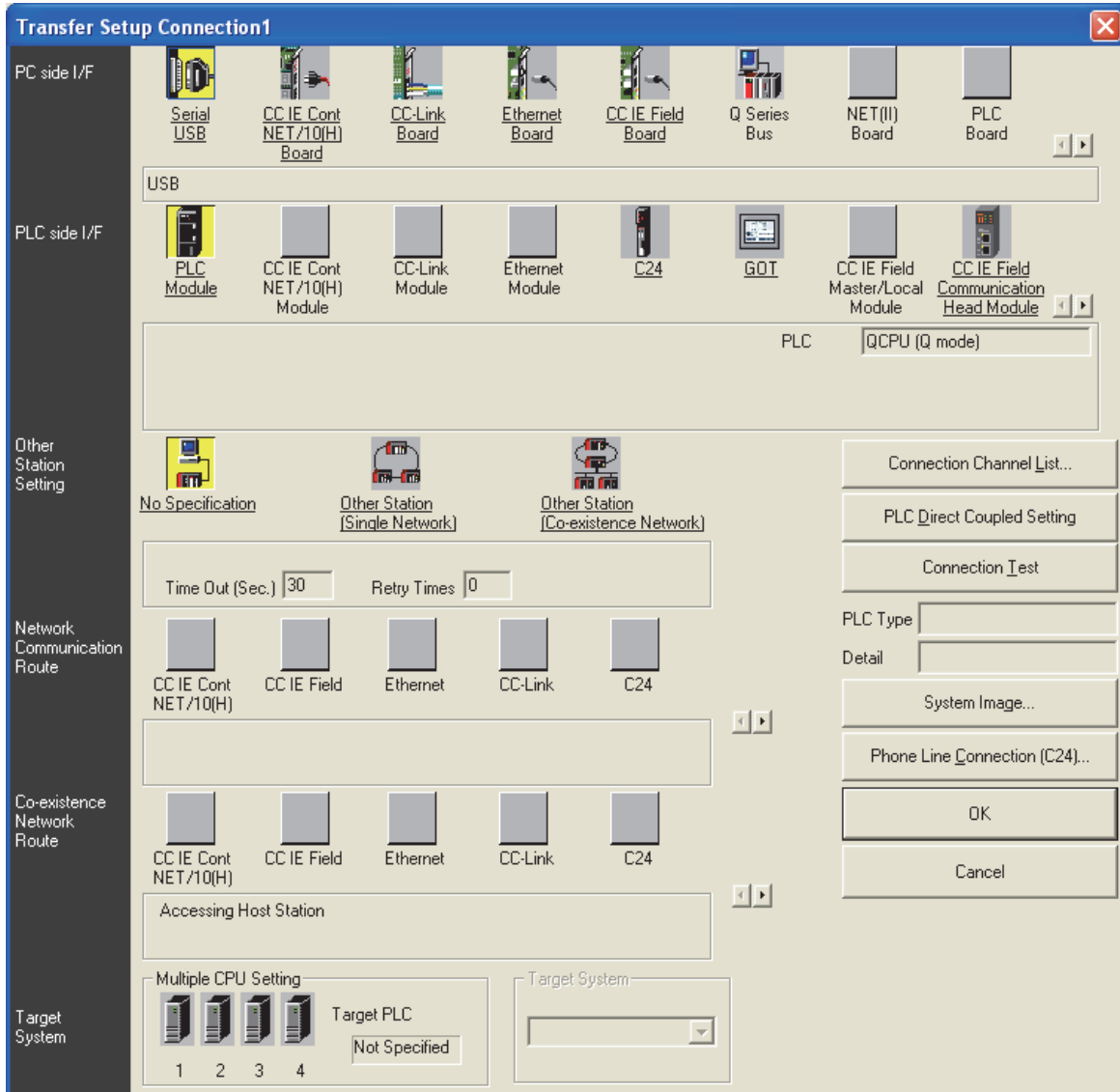

(b) "Transfer Setup" window

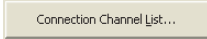

(3) Operation buttons

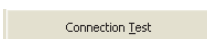
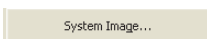
Item	Description	Reference
 button	Displays a list of routes. Since a route selected from the list is automatically set in the "Transfer Setup" window, the setting is easy even in the case of a complex system.	Page 140, Section 8.6.4
 button	Enables the setting for directly connecting the CPU module and a personal computer.	Page 136, Section 8.6.1
 button	Checks if an access to the CPU module specified in the "Transfer Setup" window is possible or not. If the access is made properly, the model name of the accessed CPU module is displayed in the "PLC Type" box.	Page 140, Section 8.6.3
 button	Displays a graphical image of the configured route.	—

8.6.2 Connection via a network

The following explains the window operation.



(1) Operating procedure

1. In the "PC side I/F" area, select and double-click an interface on the personal computer where the configuration tool is installed.
2. In the "PLC side I/F" area, select and double-click an interface on the CPU module side.
3. In the "Other Station Setting" area, specify the presence or absence of other stations.
4. In the "Network Communication Route" area, configure the settings of the network to be routed for access to another station, and click the  button. (The settings differ depending on the network type.)

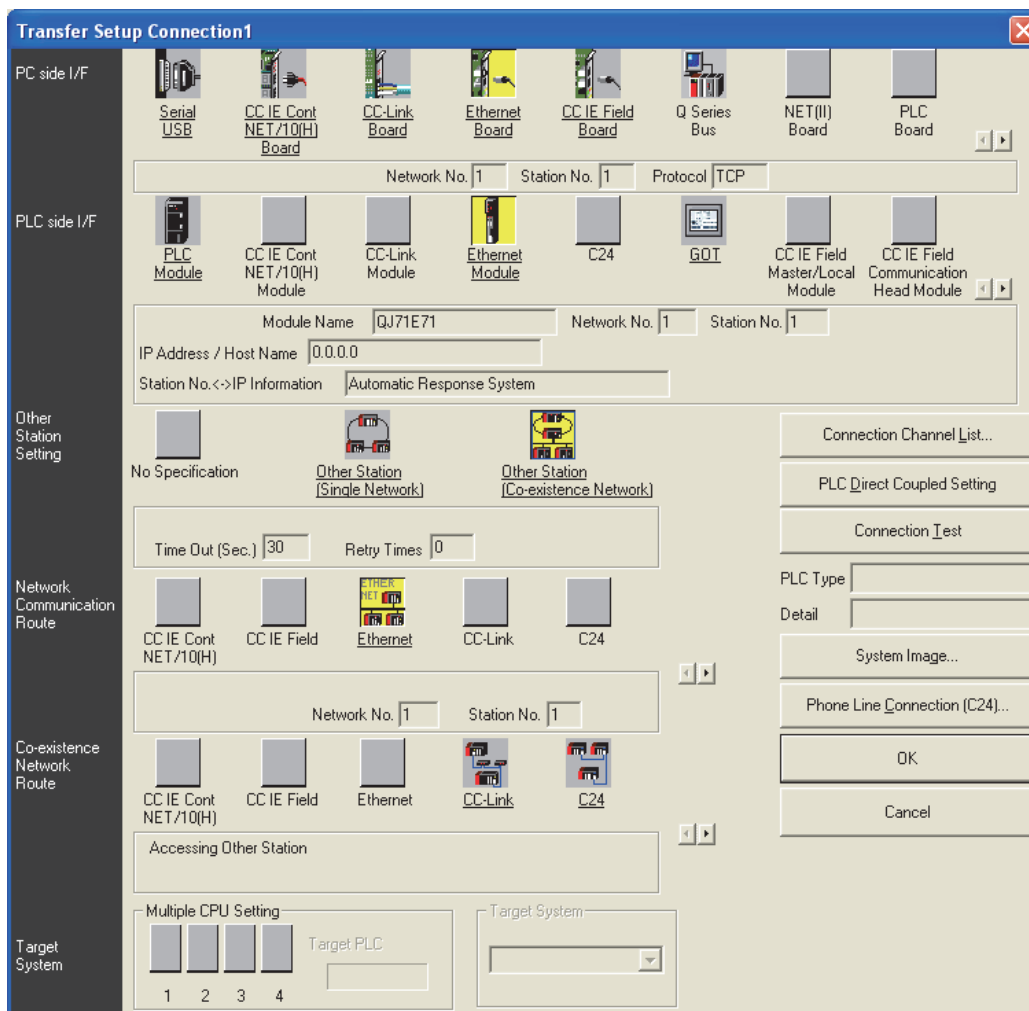
(2) Setting window

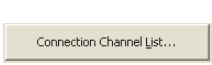
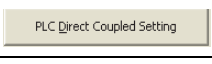

(3) Setting items and buttons

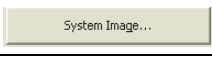
Item		Description	Reference
PC side I/F		Set the interface of the personal computer.	—
PLC side I/F		Set the interface on the CPU module side.	—
Other Station Setting	No Specification	Select this when accessing the LCPU that is directly connected to the personal computer.	—
	Other Station (Single Network)	Select this when accessing a CPU module on another station via a single network (including a multi-layer system).	—
	Other Station (Co-existence Network)	Select this when connecting a personal computer and a Q series CPU module and accessing from the CPU module to another CPU module on another station via CC-Link or a serial communication module.	—
Network Communication Route		For an access to another station via a network, select a network type, and specify the network No. and station No. and head I/O. The settings differ depending on the network type.	—
 button		Displays a list of routes. Since a route selected from the list is automatically set in the "Transfer Setup" window, the setting is easy even in the case of a complex system.	Page 140, Section 8.6.4
 button		Enables the setting for directly connecting the CPU module and a personal computer.	Page 136, Section 8.6.1
 button		Checks if an access to the CPU module specified in the "Transfer Setup" window is possible or not. If the access is made properly, the model name of the accessed CPU module is displayed in the "PLC Type" box.	Page 140, Section 8.6.3
 button		Displays a graphical image of the configured route.	—

8.6.3 Connection test

Check whether connection is available or not on the route set in the "Transfer Setup" window.

(1) Operating procedure

1. Set a route in the "Transfer Setup" window, and click the  button.
2. When the connection is successfully established, the following message is displayed.

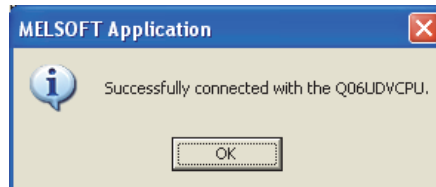

8.6.4 Connection channel list

In the "Connection Channel List" window, a graphic image of each route in the list can be viewed and then a desired one can be selected.

The route selected in the "Connection Channel List" window is set in the "Transfer Setup" window. Set any network number and station number according to the access target.

(1) Displayed window

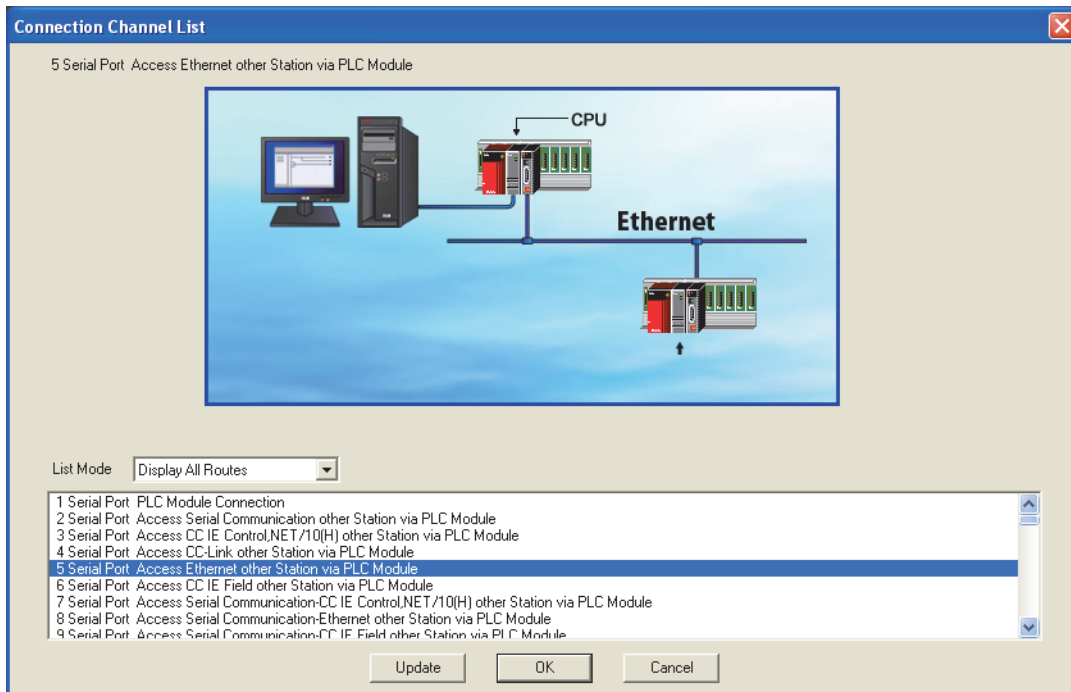

(2) Setting items

Item	Description
Display All Routes	All of supported routes are displayed.
Display Selected Routes	The routes available for the Other Station Setting and Network Communication Route settings are displayed.

8.6.5 Searching CPU modules on the network

CPU modules on the Ethernet network can be searched and the search results are displayed as a list if they are connected to the hub to which the configuration tool is also connected.

(1) Operating procedure

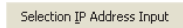
1. In the "Transfer Setup" window, select "Ethernet Board" for "PC side I/F", and double-click "PLC Module" of "PLC side I/F".
2. Select a CPU mode for "PLC Mode".
3. Select "Connection via HUB", and click the  button.
4. Select a target CPU module from the CPU information list, and click the  button.

(2) Setting window

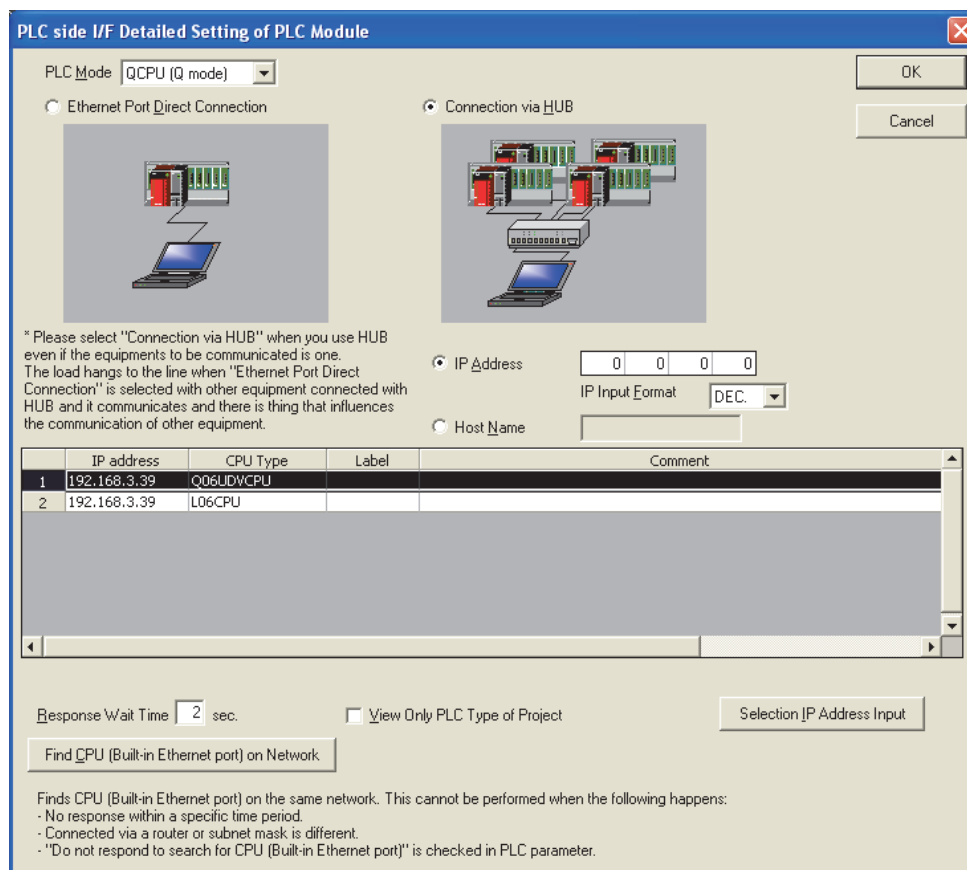

(3) Setting items and buttons

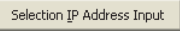
Item		Description
PLC Mode		Select a mode of the CPU module that is connected to the personal computer.
Ethernet Port Direct Connection		Select this when directly connecting a personal computer to the Ethernet port of the CPU module with a cable.
Connection via HUB	—	Select this when connecting a personal computer to the CPU module by specifying an IP address.
	IP Address	Specify the IP address of the CPU module.
	Host Name	Specify the host name of the CPU module.
CPU information list		IP addresses, CPU types, labels, and comments of the detected CPU modules are displayed.
Response Wait Time		The time waiting for CPU module search results (1 to 99 seconds) is displayed.
 button		Searches for CPU modules on the network and displays the CPU information list.
 button		Automatically enters the IP address of the CPU module selected in the CPU information list into the "IP Address" setting area.

Point

For Windows Vista® or Windows®7 and later, the following message may appear when the  button is clicked.

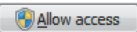

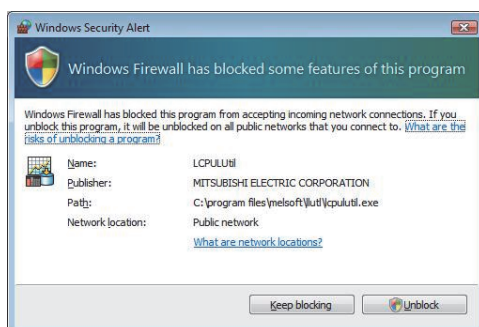
Click the  button for Windows Vista®, and the  button for Windows®7 and later to continue the operation. (The following window image is from Windows Vista®.)



8.7 Reading the Data Logging Setting from the CPU Module

Data logging setting data can be read out from the target memory of the CPU module.

(1) Operating procedure

1. Display the "Online Operation (Read out Logging Setting)" window.
 [Online] ⇒ [Read Logging Setting]
2. From the "Target memory" list, select the memory where the data to be read are stored.
3. Select the target data in the "Target logging setting data" area.
4. Click the  button.

Point

- If some data currently exist in the configuration tool before reading, the common settings and the setting data with the same setting No. will be overwritten. Data other than the above will be held in the configuration tool. Because of this, the data to be read out may not match the data read out.
 - If a remote password entry window appears, enter the configured password.
For the remote password, refer to the following.
 User's Manual (Function Explanation, Program Fundamentals) for the CPU module used
-

(2) Setting window

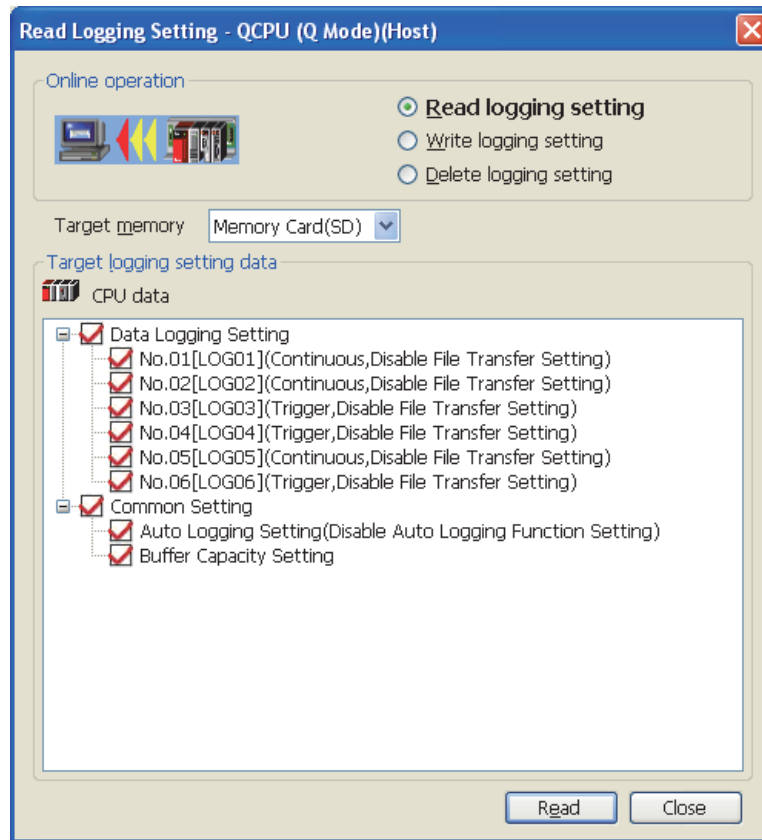

(3) Setting items

(a) Data logging setting

"Setting No. [data logging name] (logging type, file transfer setting status)" is displayed in Data Logging Setting.

(b) Display of Common setting

Display of Common setting differs depending on the target memory.

- Standard ROM: "Buffer Capacity Setting" only is displayed.
- SD memory card: "Buffer Capacity Setting" and "Auto Logging Setting (auto logging setting status)" are displayed.

8.8 Writing the Data Logging Setting to the CPU Module

Data logging setting data can be written to the target memory of the CPU module.

Point

Stop the target data logging before writing the data logging setting. Also, all of the data loggings must be stopped when writing the common settings.

(1) Operating procedure

1. Display the "Online Operation (Write Logging Setting)" window.

 [Online] ⇒ [Write Logging Setting]

2. From the "Target memory" list, select the memory where the data are to be written.
3. Select the target data in the "Target logging setting data" area.
4. Click the  button.

Point

- If some data currently exist in the CPU module before writing, the common settings and the settings with the same No. will be overwritten. Data other than the above will be held in the CPU module. Because of this, the data to be written may not match the data written.
- If a remote password entry window appears, enter the configured password.
For the remote password, refer to the following.
 User's Manual (Function Explanation, Program Fundamentals) for the CPU module used
- The data logging file transfer function cannot be used while the auto logging function is enabled. Check that the auto logging function is disabled in advance.

(2) Setting window

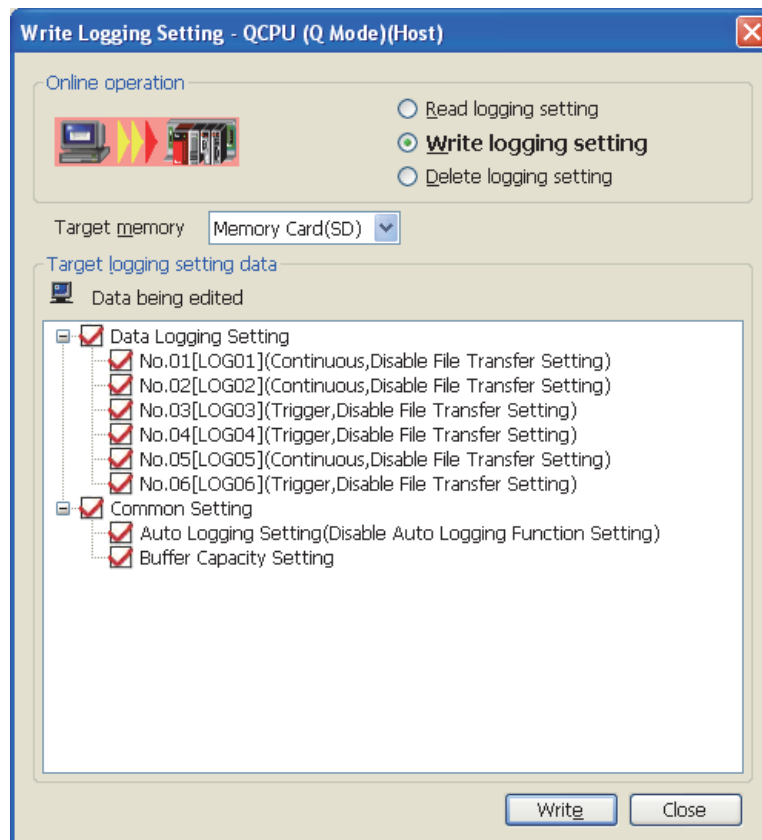

(3) Setting items

(a) Data logging setting

"Setting No. [data logging name] (logging type, file transfer setting status)" is displayed in Data Logging Setting.

(b) Display of Common setting

Display of Common setting differs depending on the target memory.

- Standard ROM: "Buffer Capacity Setting" only is displayed.
- SD memory card: "Buffer Capacity Setting" and "Auto Logging Setting (auto logging setting status)" are displayed.



Be sure to write the common settings to the CPU module before executing data logging.

8.9 Deleting the Data Logging Setting in the CPU Module

Data logging setting data in the target memory of the CPU module can be deleted.

(1) Operating procedure

1. Display the "Online Operation (Delete Logging Setting)" window.

 [Online] ⇒ [Delete Logging Setting]

2. From the "Target memory" list, select the memory where the data to be deleted are stored.
3. Select the target data in the "Target logging setting data" area.
4. Click the  button.

Point

If a remote password entry window appears, enter the configured password.

For the remote password, refer to the following.

 User's Manual (Function Explanation, Program Fundamentals) for the CPU module used

(2) Setting window

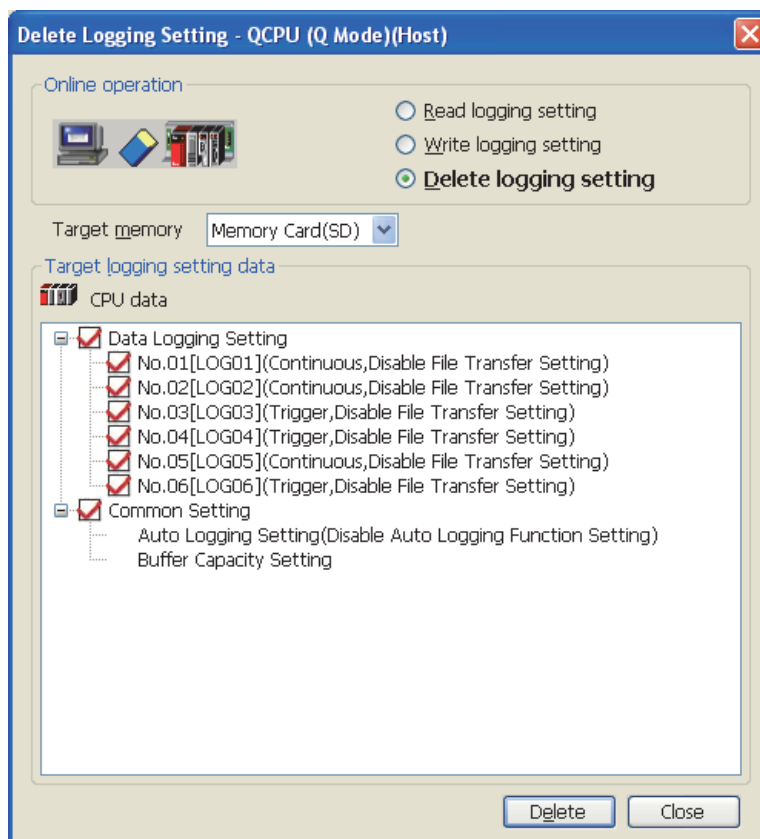

(3) Setting items

(a) Data logging setting

"Setting No. [data logging name] (logging type, file transfer setting status)" is displayed in Data Logging Setting.

(b) Display of Common setting

Display of Common setting differs depending on the target memory.

- Standard ROM: "Buffer Capacity Setting" only is displayed.
- SD memory card: "Buffer Capacity Setting" and "Auto Logging Setting (auto logging setting status)" are displayed.

8.10 Logging Status and Operation

Data logging is executed or stopped, and the status can be confirmed.

(1) Operating procedure

1. Open the "Logging Status and Operation" window.



 [Online] ⇒ [Logging Status and Operation]

2. Select the target setting number(s). (Multiple choice available)

3. With the button, start the data logging. (Simultaneously executable when multiple settings are selected.)

4. Click the button to temporarily stop the data logging, and click the button to stop. (Simultaneously executable when multiple settings are selected.)

Point

- Data logging does not start only by turning off the power and then on or resetting after writing the configuration. To start the data logging, be sure to click the button in the "Logging Status and Operation" window.
- For trigger logging, a data logging setting cannot be registered if the trigger conditions are met at the time of registration.
- New data logging cannot be started when the logging status is as follows:
 - Executing
 - Saving the logging data
 - Completion
 - Pausing
 - Error (other than registration errors)
- It takes time to stop or temporarily stop a data logging after the stop or pause operation is performed from the configuration tool. (After the stop or pause operation, logging actually stops or pauses when saving the data in the buffer to the SD memory card is completed.)
- After the start operation is performed from the configuration tool, a timeout error may occur, and data logging may be suspended. ( Page 184, Section 13.2.4)
- If a remote password entry window appears, enter the configured password.
For the remote password, refer to the following.
 User's Manual (Function Explanation, Program Fundamentals) for the CPU module used
- Data logging cannot be started while data logging files are transferred to the FTP server. Performing the start operation will open a window. Whether to stop the transfer to start data logging or not can be selected in the window. ( Page 91, Section 7.4.6 (6))

(2) Setting window

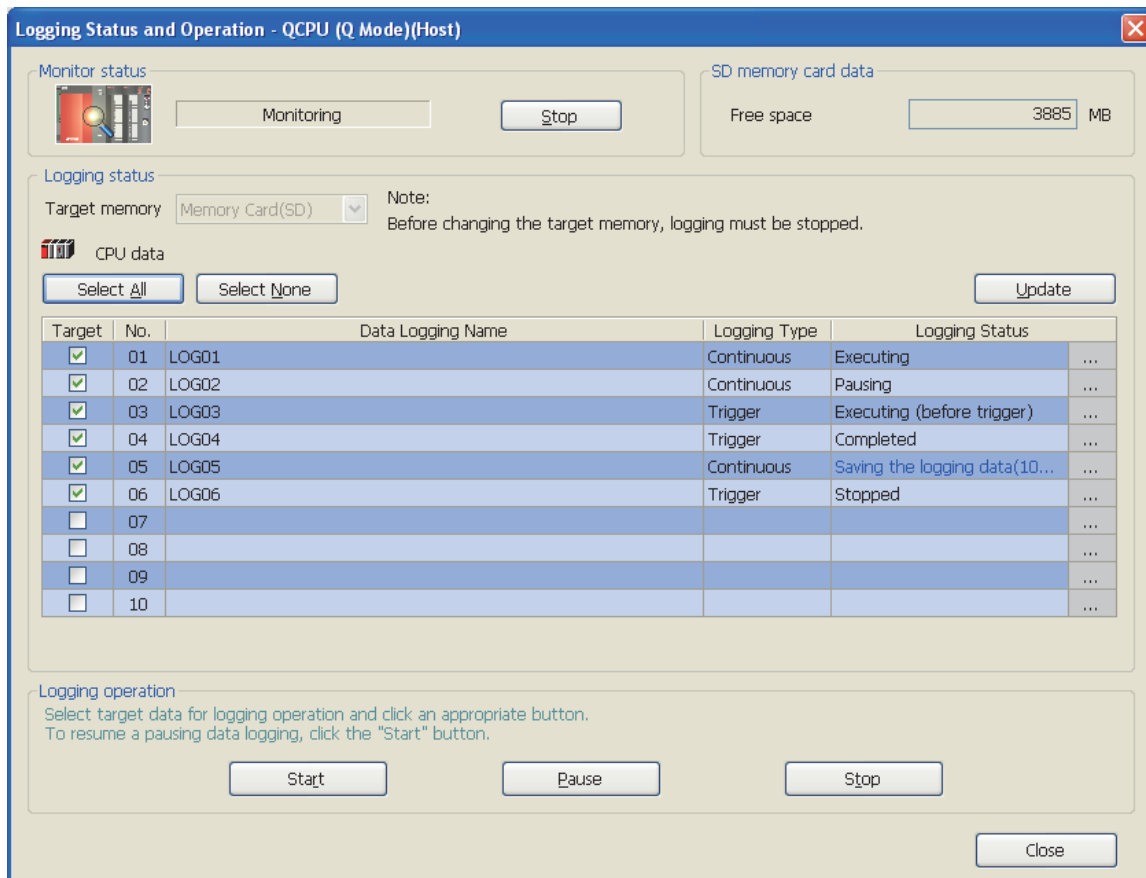

(3) Setting items and buttons

Item	Description	
Start (Stop)	Monitoring starts when it is stopped. Or, monitoring stops when monitoring is in execution.	
SD memory card data	Free space in the SD memory card is displayed.	
button	Selects all of the setting data.	
button	Clears all of the target settings.	
Target memory	Select a memory that is the target for the data logging status and operation. (Selectable only when all of the data loggings are stopped.)	
Logging status	Target	Select any target setting data.
	No.	Setting No. is displayed.
	Data Logging Name	The data logging name is displayed.
	Logging Type	The logging type is displayed.
	Logging Status	The logging status is displayed.
button	This button is displayed on the extreme right of each line if an error occurs. Clicking this will display the "Details" window. (Page 151, Section 8.10 (4) (a))	
button	Executes logging of the selected setting data.	
button	Temporarily stops logging of the selected setting data.	
button	Stops logging of the selected setting data.	

(4) Error window

(a) Error details window

The following is an example of the error details window, "Details", which appears when the  button is clicked in the event of an error.

Displays a value that will be stored in the special register or an error response No.

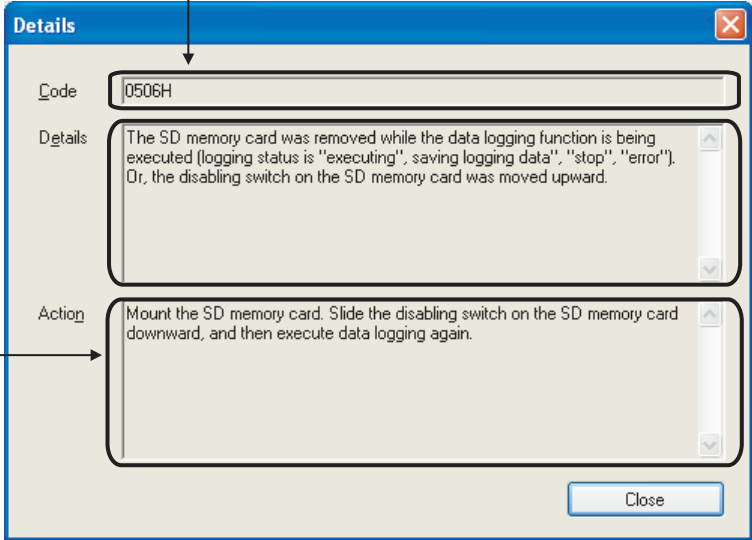

Displays error details.

Displays corrective action for the error.

(b) Error window displayed during operation

The following is an example of the "Result" window, which appears when an error occurs during operation of the setting data.

Failed to execute logging.
Refer to the following for the details.

Operation result

No.	Data logging name	Logging type	Operation Result
01	LOG01	Continuous	Error
02	LOG02	Continuous	Normal
03	LOG03	Trigger	Normal
04	LOG04	Trigger	Normal
05			-
06			-
07			-
08			-
09			-
10			-

Error details

Code: 4277H

Details: Data logging was registered with the number of saved files exceeding the set number while the operation for exceeding file number was set to "Stop". Or, data logging was registered with the number of saved files exceeding the set number while the operation...

Action: Execute again after deleting the files in the memory for storing the data logging results or changing the save destination because the set number of saved files has been exceeded.

Displays a value that will be stored in the special register or an error response No.

Displays error details.

Displays corrective action for the error.

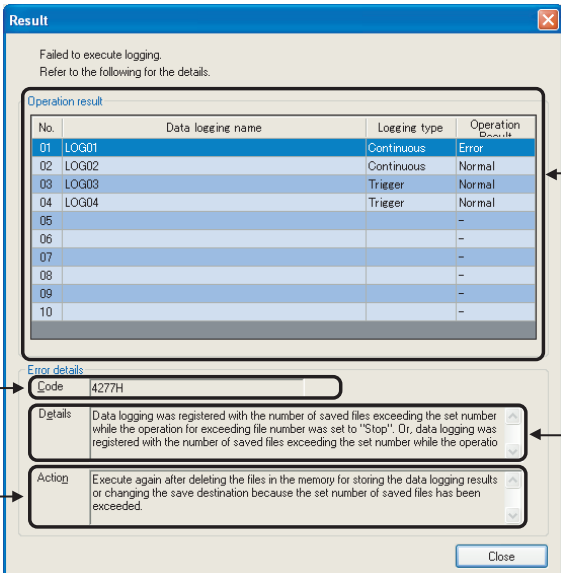

8.11 Logging File Operation

Data logging files in the SD memory card can be saved in or deleted from the personal computer.

(1) Operating procedure

1. Configure the Transfer Setup settings. (☞ Page 136, Section 8.6)
2. Open the "Logging File Operation" window.
 [Online] ⇒ [Logging File Operation]
3. Select the target file and execute it. (Simultaneously executable when multiple files are selected.)





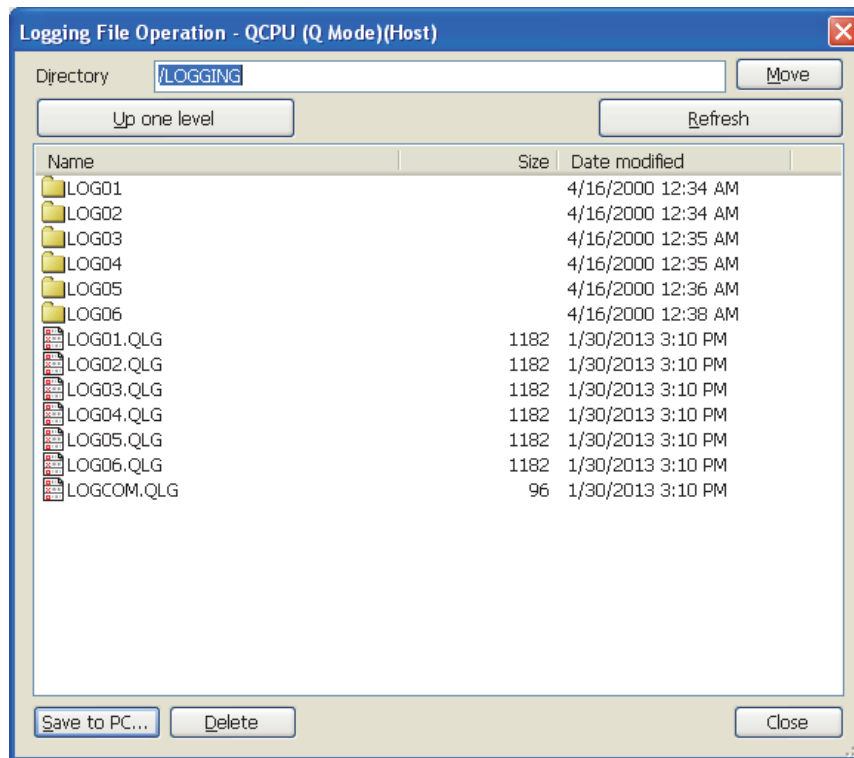

Point

- It may take time to save a data logging file, and updating of other monitoring results may be delayed when:
 - The data logging file is stored during execution of data logging.
 - A large-size data logging file is stored.
 - If a remote password entry window appears, enter the configured password.
For the remote password, refer to the following.
 User's Manual (Function Explanation, Program Fundamentals) for the CPU module used
-

(2) Setting window



(3) Setting item and buttons

Item	Description
Directory	The path for the current folder (directory) is displayed. Or, the path for the destination folder (directory) is specified.
 button	Moves to the specified folder (directory).
 button	Moves to the parent folder (directory).
 button	Updates the information.
 button	Opens the "Save As" window to save the selected file to the personal computer.
 button	Deletes the selected file or folder.*1
 button	Closes the "Logging file operation" window.

*1 With the LCPU, only files can be deleted.

8.12 Data Logging File Transfer Status

Transfer status of data logging files can be checked.

(1) Operating procedure



Check transfer status in the "Data Logging File Transfer Status" window.

 [Online] → [Data Logging File Transfer Status]

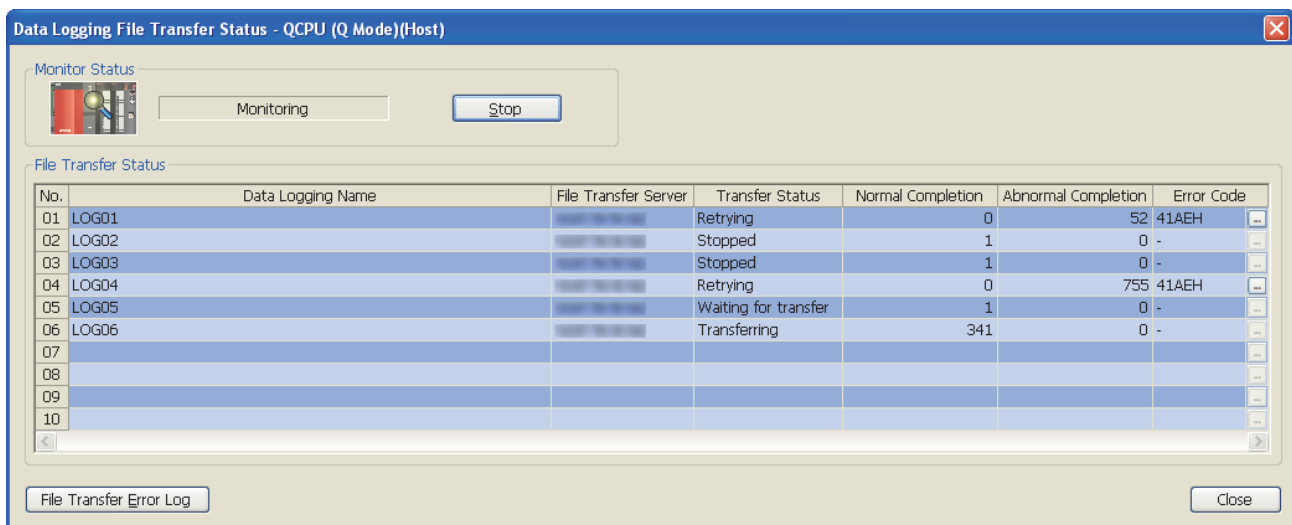
(2) Displayed window



(3) Displayed items and buttons

Item		Description
Start (Stop)		Monitoring starts when it is stopped. Or, monitoring stops when monitoring is in execution.
File Transfer Status	No.	The data logging setting No. is displayed.
	Data Logging Name	The data logging name is displayed.
	File Transfer Server	The IP address of transfer destination FTP server is displayed.
	Transfer Status	Transfer status of a data logging file is displayed. ( Page 89, Section 7.4.5)
	Normal Completion	The number of data logging files that were successfully transferred to the FTP server is displayed.
	Abnormal Completion	The number of data logging files failed to be transferred to the FTP server is displayed.
	Error Code	The latest error code of the data logging file transfer function is displayed.
	 button	This button is displayed if an error occurs. Clicking this will display the "Details" window.
 button	Clicking this button will display the error log window.	

Point

The data logging file transfer function continues to be operated even after data logging setting files are deleted. Until when a new data logging setting is overwritten, information of the deleted files remains displayed in each item in the "Data Logging File Transfer Status" window.

(4) File Transfer Error Log window

(a) Displayed window

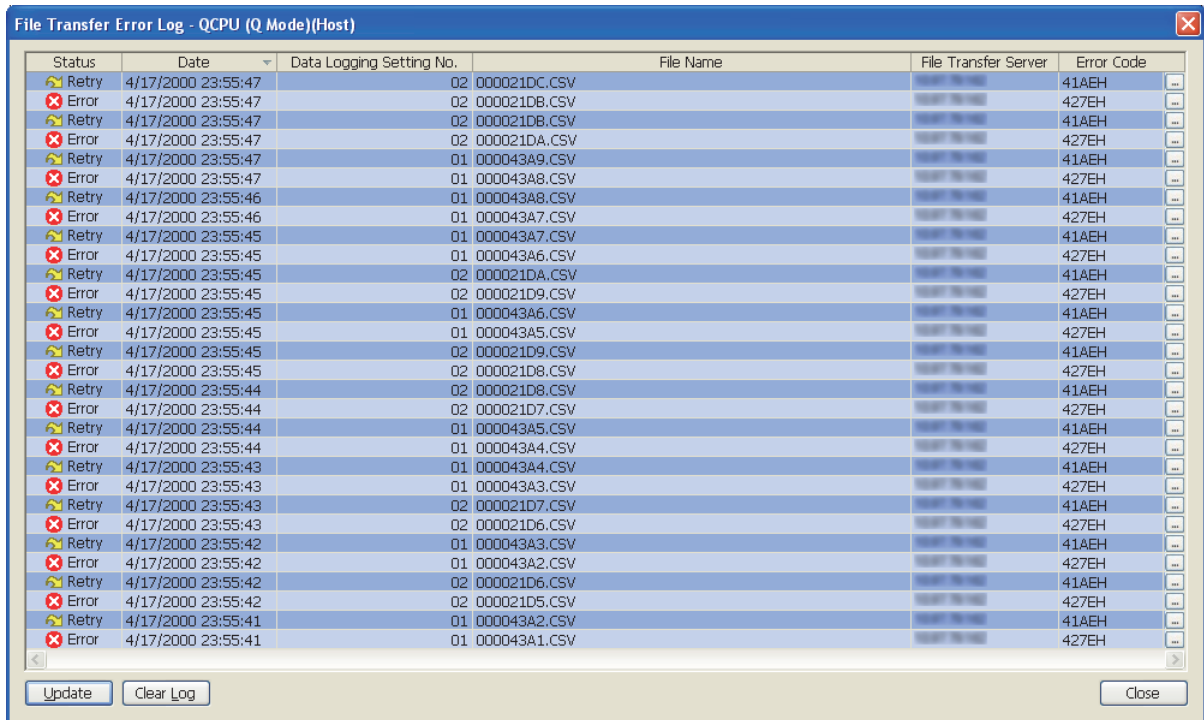

(b) Displayed items and buttons

Item	Description
Status	Transfer status of a file is displayed. • Error • Retry
Date	The time and date when a data logging file transfer function error occurred are displayed.
Data Logging Setting No.	The data logging setting No. where a data logging file transfer function error occurred is displayed.
File Name	The data logging file name in which a data logging file transfer function error occurred is displayed.
File Transfer Server	The transfer destination server name where a data logging file transfer function error occurred is displayed.
Error Code	Detected data logging file transfer function error is displayed.
button	This button is displayed if an error occurs. Clicking this will display the "Details" window.
button	Clicking this button will obtain error logs in the CPU module again and display them.
button	Clicking this button will clear error logs in the CPU module.

8.13 Checking the Product Information

There are two help functions in the configuration tool:

- Opening the user's manual
- Checking the version information

8.13.1 Opening the user's manual

e-Manual Viewer starts, and the manual opens.

(1) Operating procedure

Perform the following.

 [Help] ⇒ [Open Manual]

8.13.2 Checking the version information

Information on the version of the configuration tool is displayed.

(1) Operating procedure

Perform the following.

 [Help] ⇒ [About Configuration tool]

8.14 Available Characters

This section describes characters available for the setting items.

8.14.1 Available ASCII characters

Characters in the shaded area can be used. Entry of an invalid character is not possible, or causes an error.

	0	1	2	3	4	5	6	7	8	9	A	B	C	D	E	F
0	NULL		(SP)*1	0	@	P	'	p				-	タ	ミ		
1			!	1	A	Q	a	q			。	ア	チ	ム		
2			"	2	B	R	b	r			「	イ	ツ	メ		
3			#	3	C	S	c	s			」	ウ	テ	モ		
4			\$	4	D	T	d	t				エ	ト	ヤ		
5			%	5	E	U	e	u			.	オ	ナ	ユ		
6			&	6	F	V	f	v			.	カ	ニ	ヨ		
7			'	7	G	W	g	w			ヲ	キ	ヌ	ラ		
8			(8	H	X	h	x			ア	ク	ネ	リ		
9)	9	I	Y	i	y			イ	ケ	ノ	ル		
A			*	:	J	Z	j	z			ウ	コ	ハ	レ		
B			+	;	K	[k	{			エ	サ	ヒ	ロ		
C			,	<	L	¥					ハ	シ	フ	ワ		
D			-	=	M]	m	}			ユ	ス	ハ	ソ		
E			.	>	N	^	n	~			ヨ	セ	ホ	”		
F			/	?	O	_	o				ッ	ソ	マ	°		

The table below shows the other characters available for respective settings.

Setting	Part	ASCII character																
		(SP)*1	"	'	*	+	,	/	:	;	<	>	?	[\]		.
Directory	Logging result operation	×	×	○	×	×	×	○	×	×	×	×	×	○	×	○	×	○
Data name line string	Data logging setting	○	×	○	○	○	×	○	○	×	○	○	○	○	○	○	○	○
• Data logging name • Data name • When trigger condition rises (trigger information column) • Comment		○	×	○	○	○	×	○	○	×	○	○	○	○	○	○	○	○
• Data name line string (date column) • Data line output format (date column)		○	×	○	○	○	×	○	○	×	○	○	○	○	○	○	○	○
File save destination		×	×	○	×	○	×	×	×	×	×	×	×	○	×	○	×	×

*1 (SP) represents space.

8.14.2 Characters available for file and folder (directory) names

Characters in the shaded area can be used.

	0	1	2	3	4	5	6	7	8	9	A	B	C	D	E	F
0	NULL		(SP)	0	@	P	'	p				-	タ	ミ		
1			!	1	A	Q	a	q			。	ア	チ	ム		
2			"	2	B	R	b	r			「	イ	ツ	メ		
3			#	3	C	S	c	s			」	ウ	テ	モ		
4			\$	4	D	T	d	t				エ	ト	ヤ		
5			%	5	E	U	e	u			.	オ	ナ	ユ		
6			&	6	F	V	f	v			.	カ	ニ	ヨ		
7			'	7	G	W	g	w			ヲ	キ	ヌ	ラ		
8			(8	H	X	h	x			ア	ク	ネ	リ		
9)	9	I	Y	i	y			イ	ケ	ノ	ル		
A			*	:	J	Z	j	z			ウ	コ	ハ	レ		
B			+	;	K	[k	{			エ	サ	ヒ	ロ		
C			,	<	L	¥	l				ヤ	シ	フ	ワ		
D			-	=	M]	m	}			ユ	ス	ハ	ソ		
E			.	>	N	^	n	~			ヨ	セ	ホ	”		
F			/	?	O	_	o				ツ	ソ	マ	°		

8.14.3 Characters available for the data logging setting

In the following cases, characters cannot be entered to the data logging setting window.

- The input character is not supported as a character code of OS language. (Example: A single-byte katakana is entered to the data logging setting created with the configuration tool (English version).)
- The language of the character code differs from that of the characters that have been entered to the data logging setting window. (Example: Characters unique to Japanese (such as single-byte katakana) and Chinese characters are used together.)

CHAPTER 9 SD MEMORY CARD

For the specifications and part names of SD memory cards, refer to the following.

 User's Manual (Hardware Design, Maintenance and Inspection) for the CPU module used

9.1 Precautions for Using SD Memory Cards

This section describes the precautions for using SD memory cards.

(1) Power-off or reset of the CPU module while accessing the SD memory card

If the CPU module is powered off or reset while the data in the buffer is being stored to the SD memory card, the file system of the SD memory card may corrupt. In this case, the CPU module diagnoses the SD memory card (checks the file system and restores data) upon power-on or reset. Note, however, that the file system may not be completely restored depending on the corruption.

The following processing time is required to diagnose the SD memory card (if 10000 files are stored in it and not fragmented).^{*1*2}

Model	Processing time required to diagnose the card	
	QnUDVCPU, QnUDPVCPU	LCPU
NZ1MEM-2GBSD	Approx. 7 seconds	Approx. 12 seconds
NZ1MEM-4GBSD	Approx. 8 seconds	Approx. 25 seconds
NZ1MEM-8GBSD	Approx. 9 seconds	Approx. 43 seconds
NZ1MEM-16GBSD	Approx. 10 seconds	Approx. 80 seconds

*1 The time for diagnostics is longer as the SD memory card is in the following condition, and it may take several minutes in some cases.

- A large number of files are stored.
- More files in the SD memory card are fragmented.

*2 When an external communication device is connected to the CPU module, if they are simultaneously activated, a communication timeout may occur on the external communication device side.

(2) Time for saving data to an SD memory card before data logging stop or pause

Data logging is stopped or temporarily stopped after all the collected data are saved in the SD memory card. For this reason, it takes time for the actual data logging operation to stop or pause after a stop or pause operation is performed. (When a small value is set for "Number of records" or "File size" in "File switching timing", it takes longer time.)

For operations associated with the above data saving to an SD memory card, refer to  Page 75, Section 6.9 (12).

Point

The operating status of the CPU module does not change during data saving to an SD memory card.

Memo

CHAPTER 10 PROCESSING TIME

This chapter describes the processing time required for data logging.

10

10.1 Data Logging Processing Time

This section describes the data logging processing time, which was measured under the specified conditions. Note that the processing time may increase depending on any of the following factors.

- Scan time
- Data logging setting
- Target data value (The CSV file size varies depending on this value.)
- SD memory card type
- Number of files in the SD memory card and file capacity

Use the measurement results described in this section for reference.

10.1.1 Continuous logging, specification period logging

The value shown is measured with the minimum allowable sampling time specified and without missing any data during continuous logging or specification period logging.

For specification period logging, the value shown is a period during which data are sampled while the conditions of the specification period are met.

(1) Measurement condition

Item		Description
Scan time		1.0ms
Buffer capacity		128 bytes per setting (default)
Data logging setting	Sampling	Time specification (Data are sampled at the specified time intervals.)
	Data	Data: Data register (D) (Data type: word (signed) (decimal))
	CSV output	The Date (default output format) and Index columns are output.
	Save	<ul style="list-style-type: none"> File switching timing: 10000 records Operation occurring when number of saved files is exceeded: Overwrite
SD memory card		NZ1MEM-2GBSD, NZ1MEM-4GBSD, NZ1MEM-8GBSD, NZ1MEM-16GBSD

(2) Measurement results (when the NZ1MEM-2GBSD is used)

The measurement results should be used for reference only since the processing time varies depending on the settings and the scan time of the CPU module.

(a) When the data logging file transfer function is disabled

CPU module	Number of device points					
	8 (8 points × 1 setting)	16 (16 points × 1 setting)	64 (64 points × 1 setting)	128 (128 points × 1 setting)	256 (128 points × 2 settings)	1280 (128 points × 10 settings)
Q03UDVCPU, Q04UDVCPU, Q04UDPVCPU, Q06UDVCPU, Q06UDPVCPU, Q13UDVCPU, Q13UDPVCPU, Q26UDVCPU, Q26UDPVCPU	1.0ms	1.0ms	2.0ms	4.0ms	9.0ms	24.0ms
L02CPU, L02CPU-P	1.0ms	1.0ms	4.0ms	7.0ms	14.0ms	64.0ms
L06CPU, L06CPU-P, L26CPU, L26CPU-P, L26CPU-BT, L26CPU-PBT	1.0ms	1.0ms	4.0ms	7.0ms	14.0ms	53.0ms

(b) When the data logging file transfer function is enabled

CPU module	Number of device points					
	8 (8 points × 1 setting)	16 (16 points × 1 setting)	64 (64 points × 1 setting)	128 (128 points × 1 setting)	256 (128 points × 2 settings)	1280 (128 points × 10 settings)
Q03UDVCPU, Q04UDVCPU, Q04UDPVCPU, Q06UDVCPU, Q06UDPVCPU, Q13UDVCPU, Q13UDPVCPU, Q26UDVCPU, Q26UDPVCPU	1.0ms	1.0ms	3.0ms	6.0ms	10.0ms	41.0ms
L02CPU, L02CPU-P	1.0ms	2.0ms	5.0ms	8.0ms	16.0ms	97.0ms
L06CPU, L06CPU-P, L26CPU, L26CPU-P, L26CPU-BT, L26CPU-PBT	1.0ms	2.0ms	4.0ms	7.0ms	14.0ms	75.0ms

(3) Measurement results (when the NZ1MEM-4GBSD, NZ1MEM-8GBSD, or NZ1MEM-16GBSD is used)

The measurement results should be used for reference only since the processing time varies depending on the settings and the scan time of the CPU module.

(a) When the data logging file transfer function is disabled

CPU module	Number of device points					
	8 (8 points × 1 setting)	16 (16 points × 1 setting)	64 (64 points × 1 setting)	128 (128 points × 1 setting)	256 (128 points × 2 settings)	1280 (128 points × 10 settings)
Q03UDVCP, Q04UDVCP, Q04UDPVCP, Q06UDVCP, Q06UDPVCP, Q13UDVCP, Q13UDPVCP, Q26UDVCP, Q26UDPVCP	1.0ms	2.0ms	5.0ms	7.0ms	13.0ms	31.0ms
L02CPU, L02CPU-P	1.0ms	2.0ms	5.0ms	8.0ms	14.0ms	64.0ms
L06CPU, L06CPU-P, L26CPU, L26CPU-P, L26CPU-BT, L26CPU-PBT	1.0ms	2.0ms	5.0ms	8.0ms	14.0ms	53.0ms

(b) When the data logging file transfer function is enabled

CPU module	Number of device points					
	8 (8 points × 1 setting)	16 (16 points × 1 setting)	64 (64 points × 1 setting)	128 (128 points × 1 setting)	256 (128 points × 2 settings)	1280 (128 points × 10 settings)
Q03UDVCP, Q04UDVCP, Q04UDPVCP, Q06UDVCP, Q06UDPVCP, Q13UDVCP, Q13UDPVCP, Q26UDVCP, Q26UDPVCP	1.0ms	2.0ms	5.0ms	7.0ms	13.0ms	48.0ms
L02CPU, L02CPU-P	2.0ms	3.0ms	5.0ms	9.0ms	16.0ms	97.0ms
L06CPU, L06CPU-P, L26CPU, L26CPU-P, L26CPU-BT, L26CPU-PBT	2.0ms	3.0ms	5.0ms	8.0ms	14.0ms	75.0ms

10.1.2 Trigger logging

The following shows values of the time required for outputting a total of 200 records before and after a trigger (100 records for each) to a file when trigger logging is performed.

(1) Measurement condition

Item	Description	
Scan time	1.0ms	
Buffer capacity	128 bytes per setting (default)	
Data logging setting	Sampling	Each scanning cycle
	Data	Data: Data register (D) (Data type: word (signed) (decimal))
	CSV output	The Date (default output format) and Index columns are output.
SD memory card	NZ1MEM-2GBSD, NZ1MEM-4GBSD, NZ1MEM-8GBSD, NZ1MEM-16GBSD	

(2) Measurement results

The measurement results should be used for reference only since the processing time varies depending on the settings and the scan time of the CPU module.

(a) When the data logging file transfer function is disabled

CPU module	Number of device points					
	8 (8 points × 1 setting)	16 (16 points × 1 setting)	64 (64 points × 1 setting)	128 (128 points × 1 setting)	256 (128 points × 2 settings)	1280 (128 points × 10 settings)
Q03UDVCP, Q04UDVCP, Q04UDPVCP, Q06UDVCP, Q06UDPVCP, Q13UDVCP, Q13UDPVCP, Q26UDVCP, Q26UDPVCP	0.8s	0.8s	0.8s	0.8s	1.5s	7.0s
L02CPU, L02CPU-P	1.5s	1.5s	2.0s	3.0s	5.5s	45.0s
L06CPU, L06CPU-P, L26CPU, L26CPU-P, L26CPU-BT, L26CPU-PBT	1.5s	1.5s	2.0s	3.0s	5.5s	45.0s

(b) When the data logging file transfer function is enabled

CPU module	Number of device points					
	8 (8 points × 1 setting)	16 (16 points × 1 setting)	64 (64 points × 1 setting)	128 (128 points × 1 setting)	256 (128 points × 2 settings)	1280 (128 points × 10 settings)
Q03UDVCPU, Q04UDVCPU, Q04UDPVCPU, Q06UDVCPU, Q06UDPVCPU, Q13UDVCPU, Q13UDPVCPU, Q26UDVCPU, Q26UDPVCPU	0.8s	0.8s	0.8s	0.8s	1.5s	7.0s
L02CPU, L02CPU-P	1.5s	1.5s	2.0s	3.0s	5.5s	45.0s
L06CPU, L06CPU-P, L26CPU, L26CPU-P, L26CPU-BT, L26CPU-PBT	1.5s	1.5s	2.0s	3.0s	5.5s	45.0s

10.2 Checking the Processing Time

Data logging is the best-effort type^{*1} function.

*1 The concept of obtaining the maximum performance from the condition at the time

Logging may not be performed at the specified sampling intervals because processing time may vary depending on the configuration or other connected devices. After configuring the system, thoroughly examine the processing time before starting the system operation.

The following figure shows the process from data collection to file output.

This section also describes what is the point when checking the time required for the following processing.

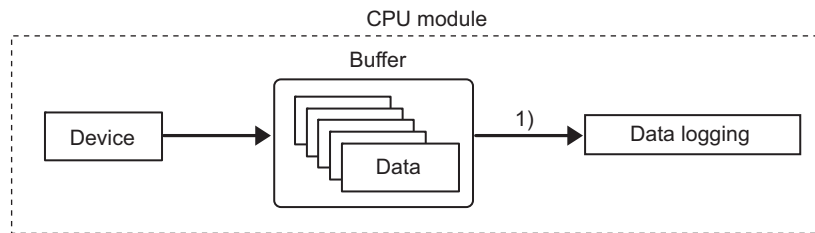

Processing	Description	Check point	Reference
1) Data logging processing	Stores the data accumulated in the buffer to a data logging file. If the data logging processing cannot keep up with the speed of the sampling processing, a processing overflow occurs and some data will be missing.	Check that all the data sampled have been processed.	Page 167, Section 10.2.1

10.2.1 Checking the data logging processing time

Check that all the data sampled by data logging (continuous logging) have been processed. The following shows the information to be checked and corrective action to be taken if an error is detected.

Information to be checked	Corrective action
Check the value in the special register (Processing timeout count). (If the special register value is other than "0", the data logging processing (file saving) does not keep up with the processing speed of the target data.)	Perform any of the following: <ul style="list-style-type: none"> • Increase the sampling interval. (☞ Page 115, Section 8.4.4) • Decrease the number of sampled data. (☞ Page 117, Section 8.4.5) • Increase the buffer capacity. (☞ Page 135, Section 8.5.2) • Decrease frequency of file switching. (☞ Page 127, Section 8.4.12) • Cancel the "File Transfer" setting in the data logging setting. (☞ Page 129, Section 8.4.13) Check the following after taking a corrective action. <ul style="list-style-type: none"> • The value in the special register (Processing timeout count) is "0". • The value in the special register (Free buffer space) does not drop to near "0" with time.

Point

For the numbers of the special register, refer to ☞ Page 178, CHAPTER 12.

10.3 Impact on Scan Time

(1) When data logging is performed

Use the following formula to calculate the increase in scan time in data logging.

[Increase in scan time]

$$KM1 + (N1 \times KM2) + (N2 \times KM3) [\mu s]$$

N1: Number of settings

N2: Number of points for internal user devices (total number of points of setting No.1 to No.10)

CPU module	KM1	KM2	KM3
Q03UDVCP, Q04UDVCP, Q04UDPVCPU, Q06UDVCP, Q06UDPVCPU, Q13UDVCP, Q13UDPVCPU, Q26UDVCP, Q26UDPVCPU	34.0	33.0	0.04
L02CPU, L02CPU-P	53.0	67.2	0.45
L06CPU, L06CPU-P	53.0	66.0	0.45
L26CPU, L26CPU-P, L26CPU-BT, L26CPU-PBT	45.0	63.0	0.35

(2) When the data logging file transfer function is executed

The following table lists the maximum increase in scan time when the data logging file transfer function is used.

CPU module	Maximum increase in scan time
Q03UDVCP, Q04UDVCP, Q04UDPVCPU, Q06UDVCP, Q06UDPVCPU, Q13UDVCP, Q13UDPVCPU, Q26UDVCP, Q26UDPVCPU	80 μ s
L02CPU, L02CPU-P	630 μ s
L06CPU, L06CPU-P, L26CPU, L26CPU-P, L26CPU-BT, L26CPU-PBT	360 μ s

10.4 Processing Time of Each Instruction

The following table lists the operation processing time of the instructions described in this manual. (Page 170, CHAPTER 11)

For details on the concept of processing time, refer to the following.

MELSEC-Q/L Programming Manual (Common Instruction)

Category	Instruction	Processing time					
		Q03UDVCPU, Q04UDVCPU, Q04UDPVCPU, Q06UDVCPU, Q06UDPVCPU, Q13UDVCPU, Q13UDPVCPU, Q26UDVCPU, Q26UDPVCPU		L02CPU, L02CPU-P		L06CPU, L06CPU-P, L26CPU, L26CPU-P, L26CPU-BT, L26CPU-PBT	
		Minimum	Maximum	Minimum	Maximum	Minimum	Maximum
Data logging instruction	LOGTRG	51,000 μ s	73,000 μ s	117.500 μ s	117.900 μ s	93.400 μ s	93.800 μ s
	LOGTRGR	10,500 μ s	17,500 μ s	24.400 μ s	24.700 μ s	19.200 μ s	19.500 μ s
	SP.LOGNAMER	8.000 μ s	18.000 μ s	—	—	—	—
	SP.LOGFILES	5.600 μ s	16.100 μ s	—	—	—	—

CHAPTER 11 DATA LOGGING INSTRUCTIONS

The following instructions are used for data logging.

Instruction		Description	Reference
LOGTRG	Trigger logging set	Causes a trigger to occur in trigger logging. Data sampled for the number of records (specified in the "Number of logging lines" window of the configuration tool) are stored in a data logging file.	Page 59, Section 6.3.2 (1), Page 171, Section 11.1
LOGTRGR	Trigger logging reset	Resets the trigger condition.	
SP.LOGNAMER* ¹	Data logging name read	Reads the data logging name of the specified data logging setting No. The data logging name is set in the "Finish" window of the configuration tool. (Page 132, Section 8.4.15)	Page 173, Section 11.2
SP.LOGFILES* ¹	Data logging file name addition	Adds a character string to the data logging file name.	Page 175, Section 11.3

*1 The instruction is available only for the High-speed Universal model QCPU and the Universal model Process CPU. Before using the instruction, check the version of the CPU module. (Page 190, Appendix 2)

11.1 Trigger Logging Set (Reset) (LOGTRG(R))

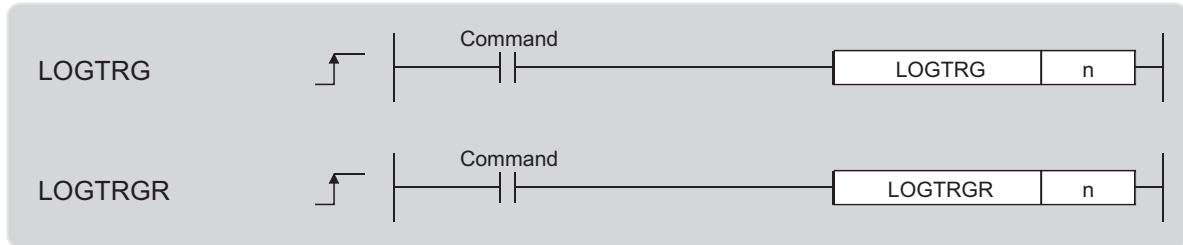

n: Data logging setting No. (BIN 16-bit)

Setting data	Internal device		R, ZR	J□□		U□\G□	Zn	Constant K, H	Others
	Bit	Word		Bit	Word				
n	—	○	○	—	—	—	○	○	—

(1) Function

(a) LOGTRG

- This instruction causes a trigger to occur for the data logging setting No.n when performing trigger logging.
- A value from 1 to 10 can be set to n.
- When this instruction is executed, the special relay (Data logging trigger) corresponding to the setting No.n turns on. Trigger logging is performed until the specified number of records (after trigger) is reached. And then, trigger logging is stopped after data latching.
- This instruction is valid when "When trigger instruction executed" is selected for trigger condition.
- The LOGTRG instruction is ignored in the following cases:
 - An item other than "When trigger instruction executed" is selected as a trigger condition of the specified data logging setting No.
 - The specified data logging setting No. has no configuration.
 - The specified data logging setting No. is performing continuous logging.
 - The LOGTRG instruction is executed again without execution of the LOGTRGR instruction.

(b) LOGTRGR

- This instruction resets the LOGTRG instruction of the specified data logging setting No. Execution of the LOGTRGR instruction enables the LOGTRG instruction of the specified trigger logging setting No.
- When this instruction is executed, the special relay (Data logging end, Data logging trigger, and After data logging trigger) of the data logging setting No.n turns off.
- If this instruction is executed while data in the buffer is being saved to the SD memory card, processing of the instruction does not start until completion of the data saving.

(2) Error

In the following case, an operation error occurs. SM0 (error flag) turns on, and an error code is stored into SD0.

- When n is other than 1 to 10 (Error code: 4100)

(3) Program example

In the program shown below, when X0 turns on, the LOGTRG instruction is executed to data logging setting No.1. And, when X1 turns on, the trigger condition is reset by the LOGTRGR instruction.

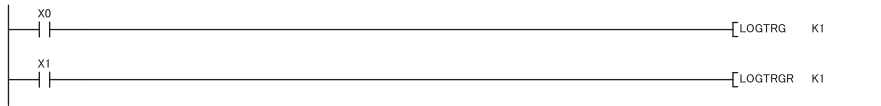

11.2 Data Logging Name Read (SP.LOGNAMER)

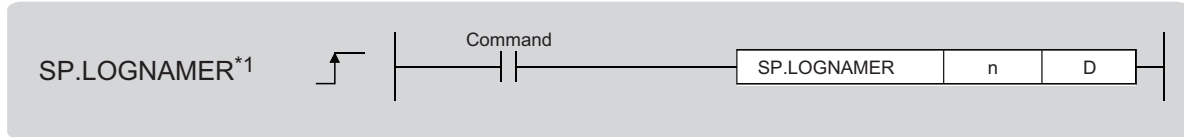

n: Data logging setting No. (BIN 16-bit)

D: Start number of a device in which the data logging name is stored (character string)

Setting data	Internal device		R, ZR	J□□		U□\G□	Zn	Constant K, H	Others
	Bit	Word		Bit	Word				
n	—	○	○	—		—	—	○	—
D	—	○	○	—		—	—	—	—

*1 The instruction is available only for the High-speed Universal model QCPU and the Universal model Process CPU. Before using the instruction, check the version of the CPU module. (☞ Page 190, Appendix 2)

(1) Function

- Reads the data logging name of the data logging setting No. specified in n. The data logging name is set in the "Finish" window of the configuration tool. The read data logging name is stored in D + 0 to D + 16. When unregistered *1 data logging setting No. is specified, 00_H is stored in D + 0 to D + 16.
- A value from 1 to 10 can be set to n.
- For the data logging name stored in D or later, 17 words are used.
- The data logging name stored in D or later is stored in Shift JIS code.
- When the logging name length stored in D or later is less than 32 characters, 00_H is stored in the remaining characters. (A two-byte character such as Chinese characters is treated as two characters.)
- 00_H is stored in the 33rd and 34th characters of the data logging name stored in D or later.

*1 "Unregistered" refers to the specific status of data logging (stopped or before starting). (☞ Page 63, Section 6.4)

Ex. When the data logging name: "LOG01" is read

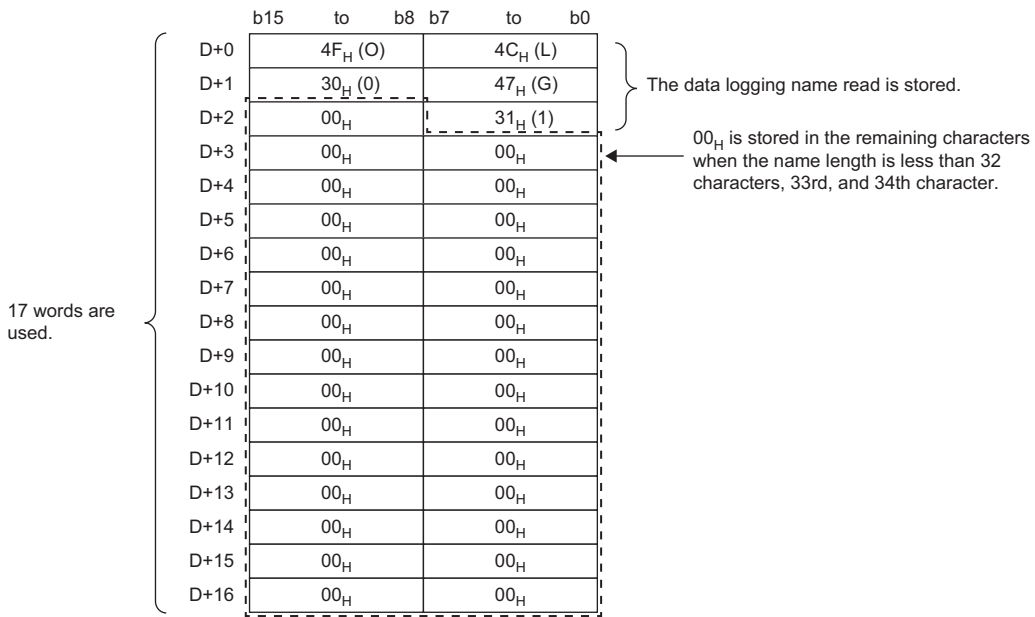

(2) Error

In the following case, an operation error occurs. SM0 (error flag) turns on, and an error code is stored into SD0.

- When n is other than 1 to 10 (Error code: 4100)
- When 17 words from the device specified in D exceed the device range (Error code: 4101)

(3) Program example

The following figure shows an example of the program to read the data logging name of the data logging setting No.1 and store the name in D0 or later when M0 turns on.



11.3 Data Logging File Name Addition (SP.LOGFILES)

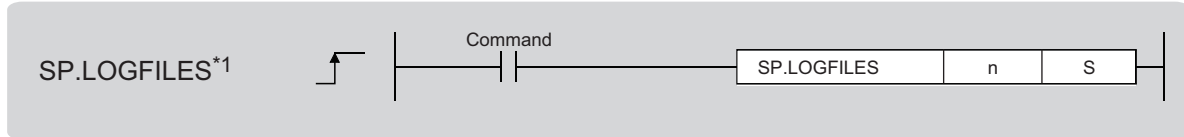

n: Data logging setting No. (BIN 16-bit)

S: Character string (8 characters maximum) added to the data logging file name or start number of the device in which a character string is stored (character string)

Setting data	Internal device		R, ZR	J□□		U□G□	Zn	Constant		Others
	Bit	Word		Bit	Word			K, H	E, \$	
n	—	○	○		—		—	○	—	—
S	—	○	○		—		—	—	○	—

*1 The instruction is available only for the High-speed Universal model QCPU and the Universal model Process CPU. Before using the instruction, check the version of the CPU module. (☞ Page 190, Appendix 2)

(1) Function

- Character string S enclosed with double quotation marks (" ") or a character string from a device number to a device number in which 00_H (null code) is stored and an underscore (_) are added to the beginning of the data logging file name subsequently created with data logging setting No.n.

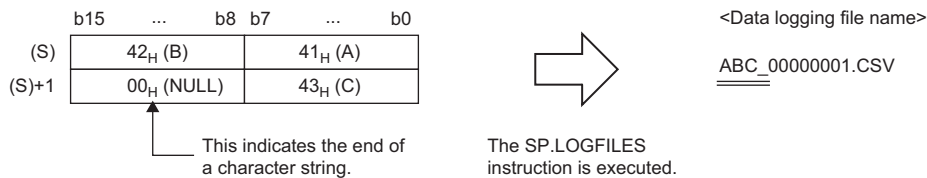

- The length of the character string S is 1 to 8 characters in ASCII characters (no two-byte characters). If the character string is valid, the bit corresponding to the setting No. of SD710 (String addition to data logging file name) is turned on. (The character string that was set when the first stack file was created is added to the data logging file name.) When 0 characters (null character) are specified, specification by the instruction is disabled, and the bit corresponding to the target setting No. is turned off. (The data logging file name returns to the status before an additional character string becomes valid (a file name specified in the configuration tool).)

Different data logging file names can be used for each specification period when this instruction is used with specification period logging (Page 61, Section 6.3.3). By executing the instruction before the conditions of the specification period are met, a character string specified as the data logging file name of the data sampled during the specification period can be added.

<Operation of the specification period logging>

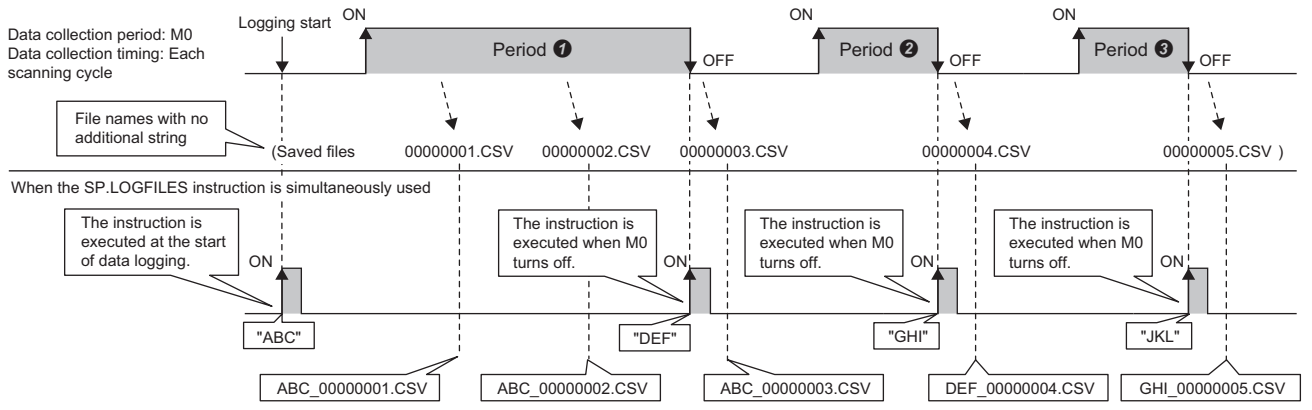

- This instruction is enabled when registered data logging setting No. is used and before the conditions are met *1. When unregistered data logging setting No. is used or the instruction is executed after the conditions are met *1, the bit corresponding to the setting No. of SD711 (data logging file name addition instruction error status) is turned on, and a character string cannot be added. SD711 is turned off when the instruction is executed and turned on when an error occurs. (SD711 remains off in a normal state.)

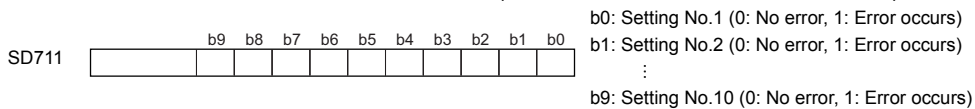

- *1 "Before the conditions are met" refers to the following:
 - When continuous logging is selected: Before the data sampling period
 - When trigger logging is selected: Before the trigger conditions are met
 - When specification period logging is selected: Before the conditions of the specification period are met
- The bit corresponding to the target setting No. of SD712 (data logging file name addition instruction next execution enable/disable status) is turned on when the execution of the instruction is accepted in the system at the time of the execution of the instruction. The bit corresponding to the target setting No. is turned off when the first stack file is created. When the instruction is executed again after the execution of the instruction in a state where a character string is not added to the file name by the instruction, the bit corresponding to the target setting No. of SD711 (data logging file name addition instruction error status) is turned on, and the character string cannot be added. It is thus recommended to execute the instruction when the bit corresponding to the target setting No. of SD712 is off. (Page 177, Section 11.3 (4)) When 0 characters (null character) are specified, specification by the instruction is disabled, and the bit corresponding to the setting No. of SD712 is turned off. A character string can thus be added by the subsequently executed instruction.

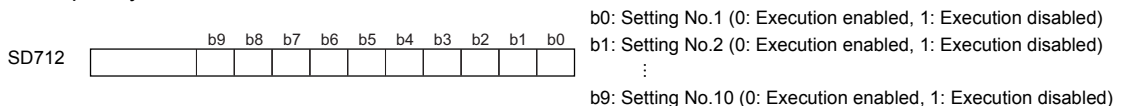

(2) Error

In the following case, an operation error occurs. SM0 (error flag) turns on, and an error code is stored into SD0.

- When n is other than 1 to 10 (Error code: 4100)
- When the data logging file name length with character string S added exceeds 48 characters (Error code: 4100)
- When character string S exceeds 8 characters (Error code: 4100)
- When an unusable character is included in character string S (Error code: 4100)

(3) Precautions

- To add another character string (to enable the instruction again) after the execution of the instruction, execute the instruction specifying a null character to void the character string that was set last time, and execute the instruction specifying another character string. When the instruction specifying a null character is not executed, the bit corresponding to the target setting No. of SD711 (data logging file name addition instruction error status) is turned on, and the character string added cannot be changed.
- When the registration is executed by writing the data logging setting of the target setting No. after the instruction is executed, addition of a character string by this instruction is disabled. (The bits corresponding to the target setting No. of SD710 to SD712 are turned off.) Therefore, execute the instruction again when adding a character string.

(4) Program example

The following figure shows an example of the program to add a character string "ABC" stored in D0 or later to the data logging file name of the data logging setting No.1 when M0 turns on.

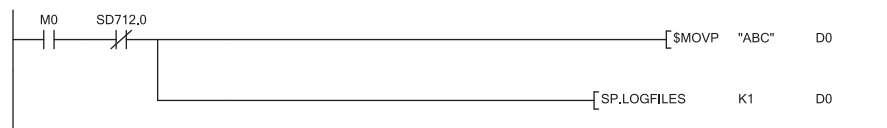

CHAPTER 12 SPECIAL RELAY AND SPECIAL REGISTER

This chapter provides the lists of the special relay and special register that are used for data logging.

12.1 Special Relay List

The special relay list for data logging is shown below. For details on each special relay area, refer to the following.

 User's Manual (Hardware Design, Maintenance and Inspection) for the CPU module used

Number	Name
SM604	Memory card in-use flag
SM624	Drive 3/4 in-use flag
SM841	Auto logging status
SM960 ^{*2}	Data logging error with/without flag
SM1938 ^{*2}	Data logging restart flag (at logging stop with error)
SM1940	Data logging setting No.1 Data logging preparation
SM1941	Data logging setting No.1 Data logging start
SM1942	Data logging setting No.1 Data logging execution
SM1943	Data logging setting No.1 Data logging end
SM1944	Data logging setting No.1 Data logging trigger
SM1945	Data logging setting No.1 After data logging trigger
SM1946	Data logging setting No.1 Data logging error
SM1947	Data logging setting No.1 Saving to SD memory card
SM1948 ^{*1}	Data logging setting No.1 Data logging file transfer execution status flag
SM1950 to SM1958 ^{*1}	Data logging setting No.2 (Data structure is the same as that of data logging setting No.1)
SM1960 to SM1968 ^{*1}	Data logging setting No.3 (Data structure is the same as that of data logging setting No.1)
SM1970 to SM1978 ^{*1}	Data logging setting No.4 (Data structure is the same as that of data logging setting No.1)
SM1980 to SM1988 ^{*1}	Data logging setting No.5 (Data structure is the same as that of data logging setting No.1)
SM1990 to SM1998 ^{*1}	Data logging setting No.6 (Data structure is the same as that of data logging setting No.1)
SM2000 to SM2008 ^{*1}	Data logging setting No.7 (Data structure is the same as that of data logging setting No.1)
SM2010 to SM2018 ^{*1}	Data logging setting No.8 (Data structure is the same as that of data logging setting No.1)
SM2020 to SM2028 ^{*1}	Data logging setting No.9 (Data structure is the same as that of data logging setting No.1)
SM2030 to SM2038 ^{*1}	Data logging setting No.10 (Data structure is the same as that of data logging setting No.1)

*1 Supported by a module with a serial number (first five digits) "12112" or later.

*2 Supported by the High-speed Universal model QCPU or the Universal model Process CPU with a serial number (first five digits) "17103" or later or the LCPU with a serial number (first five digits) "17102" or later.

12.2 Special Register List

The special register list for data logging is shown below. For details on each special register area, refer to the following manual.

 User's Manual (Hardware Design, Maintenance and Inspection) for the CPU module used

Number	Name
SD604	Memory card use conditions
SD616, SD617	Free space in drive 2 (memory card ROM)
SD624	Drive 3/4 use conditions
SD710 ^{*2}	String addition to data logging file name
SD711 ^{*2}	Instruction error (Adding a string to data logging file names)
SD712 ^{*2}	Next execution of instruction (Adding a string to data logging file names)
SD1940, SD1941	Data logging setting No.1 Latest file No.
SD1942, SD1943	Data logging setting No.1 Oldest file No.
SD1944	Data logging setting No.1 Free buffer space
SD1945	Data logging setting No.1 Processing timeout count
SD1946	Data logging setting No.1 Data logging error cause
SD1947 ^{*1}	Data logging setting No.1 Data logging file transfer function error code
SD1950 to SD1957 ^{*1}	Data logging setting No.2 (Data structure is the same as that of data logging setting No.1)
SD1960 to SD1967 ^{*1}	Data logging setting No.3 (Data structure is the same as that of data logging setting No.1)
SD1970 to SD1977 ^{*1}	Data logging setting No.4 (Data structure is the same as that of data logging setting No.1)
SD1980 to SD1987 ^{*1}	Data logging setting No.5 (Data structure is the same as that of data logging setting No.1)
SD1990 to SD1997 ^{*1}	Data logging setting No.6 (Data structure is the same as that of data logging setting No.1)
SD2000 to SD2007 ^{*1}	Data logging setting No.7 (Data structure is the same as that of data logging setting No.1)
SD2010 to SD2017 ^{*1}	Data logging setting No.8 (Data structure is the same as that of data logging setting No.1)
SD2020 to SD2027 ^{*1}	Data logging setting No.9 (Data structure is the same as that of data logging setting No.1)
SD2030 to SD2037 ^{*1}	Data logging setting No.10 (Data structure is the same as that of data logging setting No.1)

*1 Supported by a module with a serial number (first five digits) "12112" or later.

*2 Supported by the High-speed Universal model QCPU or the Universal model Process CPU with a serial number (first five digits) "20073" or later.

CHAPTER 13 TROUBLESHOOTING

For data logging error codes, SM, SD, and troubleshooting by symptom, refer to the following.
 📖 User's Manual (Hardware Design, Maintenance and Inspection) for the CPU module used

This chapter provides only the list of the errors that may occur in data logging.

13.1 List of the Errors That May Occur in Data Logging

If an error occurs in data logging, a diagnostic error will not be reported. Instead, the special relay (Data logging error) turns on and a value indicating the cause of the error is stored in the special register (Data logging error cause).
 If the data logging is stopped with an error, the logging can be restarted by using SM1938 (Data logging restart flag (at logging stop with error)).*1

For information on "Registration" and "Cancel" in the "Timing of occurrence" column, refer to 📖 Page 63, Section 6.4.

*1 This flag is supported by the QnUDVCP and QnUDPVCPU with a serial number (first five digits) "17103" or later, or LCPU modules (except for the L02SCPU and L02SCPU-P) with a serial number (first five digits) "17102" or later.

No.	Error cause	Timing of occurrence	Value in special register (Data logging error cause information)	Error response No.
1	Writing or registration was attempted to the SD memory card in one of the following conditions. • An SD memory card was not installed. • LCP: An SD memory card was installed but the SD memory card access control switch was not slid down. • The SD memory card was disabled by SM606 (SD memory card forced disable instruction).	Writing settings	—	41FE _H
		Registration	208 _H	41FE _H
2	Writing or registering data logging settings was attempted to a failed memory.	Writing settings	—	4123 _H
		Registration	216 _H	
3	With the SD memory card write-protected, writing or deleting data logging settings was attempted to it.	• Writing settings • Deleting settings	—	41DF _H
4	Although the target memory does not have enough free space, writing data logging settings was attempted.	Writing settings		41CF _H
5	Writing data logging settings to the target memory was not completed.			Abnormal memory access error other than No.1 to No.4
6	While the data logging function is in operation (the logging status is "Executing", "Saving the logging data", "Completed", "Pausing", or "Error"), data logging registration to a different memory was attempted.	Registration	—	4270 _H
7	While the data logging function is in operation (the logging status is "Executing", "Saving the logging data", "Completed", "Pausing", or "Error"), writing, deleting, or registering data logging settings was attempted to Common setting or a data logging setting of a registered setting number.	• Writing settings • Deleting settings • Registration		4271 _H
8	Writing or deleting data logging settings, or data logging operation was attempted to a file in access.	• Writing settings • Deleting settings • Registration • Cancel		413B _H

No.	Error cause	Timing of occurrence	Value in special register (Data logging error cause information)	Error response No.
9	Data logging registration was attempted to a failed memory.	Registration	200 _H	4021 _H
10	In registration of the data logging, a nonexistent program name was specified.		201 _H	4022 _H
11	A program name (which exists in the CPU module but is not registered to the program setting in PLC Parameter) was specified in registration of the data logging.		202 _H	4083 _H
12	In registration of the data logging, a nonexistent device number was specified.		203 _H	4031 _H
13	In registration of the data logging, a nonexistent step number or any other than the head step number of an instruction was specified.		204 _H	4088 _H
14	Registration of the trigger logging was attempted with the trigger condition(s) already met.		205 _H	4064 _H
15	When "Stop" is selected for the setting of operation in the case of exceeding the maximum number of files to be saved, a data logging registration was attempted in a state where existing saved files are the predetermined maximum number of files or more. Or, when "Overwrite" is selected, a data logging registration was attempted in a state where existing saved files are more than the predetermined maximum number of files.		207 _H	4277 _H
16	Writing or deleting data logging settings, or data logging operation was attempted to a setting that has been already registered.	• Writing settings • Deleting settings • Registration	—	4060 _H
17	While the data logging function is in operation (the logging status is "Executing", "Saving the logging data", "Completed", "Pausing", or "Error"), registration of a data logging was attempted to the same destination as the currently executing data logging.	Registration	209 _H	427B _H
18	During online change, registration of a data logging, in which "Step No." is specified in "Sampling" or "Trigger", was attempted.		20A _H	410A _H
19	While the trigger logging function is in operation with a device specified in Trigger (the logging status is "Executing", "Saving the logging data", "Completed", "Pausing", or "Error"), registration of a trigger logging was attempted with a device specified in Trigger.		20B _H	4272 _H
20	Registration of a data logging was attempted during execution of the sampling trace function.		20C _H	4273 _H
21	Writing or deleting data logging settings, or data logging registration was attempted during execution of auto logging.	• Writing settings • Deleting settings • Registration	—	4275 _H
22	During execution of auto logging, a data logging was not registered due to registration failure of another setting No.	Registration	20D _H	—
23	Registration of a data logging, in which an invalid device name was specified, was attempted.		20E _H	4030 _H
24	Registration of a data logging, in which an invalid device modification was specified, was attempted.		20F _H	4032 _H
25	Re-registration of the previously registered data logging setting was attempted. However, the corresponding file does not exist.		211 _H	41C5 _H
26	Data logging registration was attempted to a memory where no common setting exists.		212 _H	427A _H
27	Registration of a trigger logging was attempted even though the specified number of records has exceeded the number of records that can be collected for the specified data logging buffer capacity.	215 _H	4274 _H	
28	Data logging operation was performed during execution of the CPU module change function with SD memory card (backup and restoration).	• Registration • Cancel	—	4332 _H
29	Registration of a data logging, in which a device of a nonexistent module or an inaccessible device was specified, was attempted.	Registration	217 _H	4043 _H
30	While the data logging function is in operation (the logging status is "Executing", "Saving the logging data", "Completed", "Pausing", or "Error"), execution of an inexecutable function was attempted.	During execution	—	4276 _H
31	When creating the data logging file, the target memory does not have the required free space.		501 _H	—
32	The SD memory card is write-protected. Or, data logging file writing to the target memory was not completed due to incorrect folder or file configuration.		502 _H	—

No.	Error cause	Timing of occurrence	Value in special register (Data logging error cause information)	Error response No.
33	While the saved file number has reached the maximum of FFFFFFFFH, registration of a data logging was attempted. Or, the number reached the maximum of FFFFFFFFH during execution.	Registration	213H	4278H
34			503H	
35	While the data logging function is in operation with a step number specified in "Sampling" or "Trigger" (the logging status is "Executing", "Saving the logging data", "Completed", "Pausing", or "Error"), online change was attempted.	During execution	504H	—
36	Registration of a data logging was attempted in the state where a sub-folder for storing a data logging file (or folder) cannot be created, or in the inaccessible state. Or, the file was not created or accessed in the status of "Executing" or "Saving the logging data".	Registration	214H	41CC _H
		During execution	505H	—
37	Registration of a data logging was attempted even though file (folder) creation or access is disabled because the same file (folder) name already exists is used for the data logging. Or, the file was not created or accessed in the status of "Executing" or "Saving the logging data".	Registration	218H	41CD _H
			507H	
38	The number of files in the root folder and sub-folders of the target memory, which were created from the configuration tool on a different connected device from the one at the time of registration, has exceeded the maximum.		508H	
39	One of the following was performed while the data logging function is in operation (the logging status is "Executing", "Saving the logging data", "Completed", "Pausing", or "Error"). <ul style="list-style-type: none"> The SD memory card was removed. High-speed Universal model QCPU and Universal model Process CPU: The SD memory card access control switch was pressed for one second or longer. LCPU: The SD memory card access control switch was slid up. The SD memory card was disabled by SM606 (SD memory card forced disable instruction). 	During execution	506H	—
40	System error	Any time	F00H	
41	Request or setting data error		F01H	4080H
42	Connection of the control port to the FTP server failed.	During execution	—	41AE _H
43	Disconnection of the control port with the FTP server failed.			41AF _H
44	Login to the FTP server failed.			41B0 _H
45	Execution of the FTP command to the FTP server failed.			41B1 _H
46	Connection of the data transfer port to the FTP server failed.			41B2 _H
47	Disconnection of the data transfer port with the FTP server failed.			41B3 _H
48	An error occurred during file transfer to the FTP server.			41BA _H
49	<ul style="list-style-type: none"> Data logging file transfer function settings are mistaken. A data logging setting file is corrupt. 			427C _H
50	<ul style="list-style-type: none"> A data logging file to be transferred was deleted during transfer by file switching. Reading of a data logging file failed. 			427D _H
51	<ul style="list-style-type: none"> A new data logging file is saved by file switching before a data logging file is transferred. A new data logging file is saved during retry by file switching. 			427E _H
52	File transfer failed due to the stop operation of file transfer.	427F _H		
53	A file transfer test was executed from another configuration tool during execution of a file transfer test.	4280 _H		
54	Data logging settings of a different programmable control series was registered (for the High-speed Universal model QCPU and Universal model Process CPU).	Registration	219H	4281H
55	The total sum of the buffer capacity of real-time monitor and the buffer capacity of data logging is exceeding the maximum capacity (for the LCPU).		21AH	4290H

13.2 Troubleshooting by Symptom

13.2.1 Troubleshooting on CSV file output

The following are examples of incorrect display of CSV file outputs and how to troubleshoot the problems.

Symptom	Cause	Action
Time data in the Date column are incorrect.	Clock data setting was changed after start of the data logging.	Do not change clock data of the CPU module during execution of the data logging function. (Page 75, Section 6.9 (13))
The number in the Index column is reset to 1.	Data missing has occurred.	To prevent data missing, take any of the following actions. <ul style="list-style-type: none"> • Increase the sampling interval. (Page 115, Section 8.4.4) • Decrease the number of sampled data. (Page 117, Section 8.4.5) • Increase the buffer capacity. (Page 135, Section 8.5.2) • Decrease frequency of file switching. (Page 127, Section 8.4.12) • Cancel the "File Transfer" setting in the data logging setting. (Page 129, Section 8.4.13) To consider the processing time taken to data logging, refer to Page 161, CHAPTER 10 .

13

13.2.2 Troubleshooting on SD memory cards

The following are examples of SD memory card problems and corrective actions.

Symptom	Cause	Action
<ul style="list-style-type: none"> • High-speed Universal model QCPU and Universal model Process CPU: When an SD memory card is installed while the power is on, the SD CARD LED does not turn on. • LCPU: When an SD memory card is installed and the SD memory card access control switch is slid down while the power is on, the SD LED does not turn on. 	The file system on the SD memory card is corrupt.	Power off and on or reset the module, and diagnose the condition of the SD memory card. (Page 159, Section 9.1 (1)) If the problem is not solved by the above action, format the SD memory card.
When the SD memory card is accessed from a peripheral device such as a personal computer, the size of the accessed file is 0 byte. Or, the file is corrupt and not accessible.		

 13.2 Troubleshooting by Symptom
 13.2.1 Troubleshooting on CSV file output

13.2.3 Troubleshooting on the configuration tool

The following is an example of the problem on the configuration tool and its solution.

Symptom	Cause	Action
The message, "The following settings cannot be imported because they are invalid data. (difference in versions or corrupted data)" is displayed.	Reading of the logging setting data written by an unsupported version was attempted.	Use the latest version of the configuration tool. (Page 46, Section 5.1)
An error message appears at the startup of the configuration tool.	A file required for the startup of the configuration tool is stored in a place that requires administrator privileges for access.	Start up the configuration tool with administrator privileges.

13.2.4 Troubleshooting on the entire system during operation of the data logging function

The following are examples of the system problems that may occur during operation of the data logging function and corrective actions.

Symptom	Cause	Action
It takes time to complete an access (read or write) to the SD memory card when the CPU module performs the data logging function.		<p>If the data logging is executed with the "short sampling interval" or "many sampling data" setting, access to the SD memory card will occur frequently. In that condition, accessing the SD memory card from another function will cause concentration of accesses to the SD memory card, resulting in slow completion. The following settings can reduce frequency of SD memory card access.</p> <ul style="list-style-type: none"> • Increase the sampling interval. (☞ Page 115, Section 8.4.4) • Decrease the number of sampled data. (☞ Page 117, Section 8.4.5) • Decrease frequency of file switching. (☞ Page 127, Section 8.4.12) <p>To consider the processing time taken to data logging, refer to ☞ Page 161, CHAPTER 10.</p>
When the drive enabled by a parameter is SD memory card, it takes time to start the data link of CC-Link.	Accesses are concentrated to the SD memory card.	<p>If the data logging is executed with the "short sampling interval" or "many sampling data" setting, access to the SD memory card will occur frequently. When the parameter-enabled drive is SD memory card, if frequency of access to the SD memory card in data logging is high, it takes time to read network parameters from the SD memory card and thus it takes time to start the data link. The following actions can shorten the time required for starting the data link of CC-Link.</p> <ul style="list-style-type: none"> • Store the parameters in the program memory or standard ROM. • Reduce frequency of SD memory card access by the following setting. • Increase the sampling interval. (☞ Page 115, Section 8.4.4) • Decrease the number of sampled data. (☞ Page 117, Section 8.4.5) • Decrease frequency of file switching. (☞ Page 127, Section 8.4.12) <p>To consider the processing time taken to data logging, refer to ☞ Page 161, CHAPTER 10.</p>
A timeout error occurs when a transmission or dedicated instruction is sent from a peripheral device to the CPU module in operation of the data logging function.	From the configuration tool, multiple data loggings were attempted to be started at the same time	<p>Starting multiple data loggings will temporarily increase the load on the service processing. This may slow down the communication response, causing a timeout error. By modifying the service processing setting in PLC Parameter, occurrence of a timeout error can be avoided. For the service processing setting, refer to the following.</p> <p>☞ User's Manual (Function Explanation, Program Fundamentals) for the CPU module used</p> <p>Occurrence of a timeout error can be also avoided by starting data loggings in one setting after another.</p>
	Multiple data logging settings have been registered.	<p>Since data logging settings are registered when the status changes from STOP to RUN, processing time for the status change may be increased temporarily and this may cause a timeout error.</p> <ul style="list-style-type: none"> • Increase a timeout time value of the external device. • Decrease the number of data logging settings.
It takes time to switch the operating status of the CPU module.	Data in the buffer are being saved to the SD memory card.	<p>The operating status of the CPU module does not change while data in the buffer are being saved to an SD memory card by a specific operation (such as changing the status from RUN to STOP and a stop or pause operation from the configuration tool). (☞ Page 159, Section 9.1 (2))</p> <ul style="list-style-type: none"> • Wait until the data saving is complete.
	Multiple data logging settings have been registered.	<p>Data logging settings are registered when the status changes from STOP to RUN. The operating status of the CPU module does not change during registration, regardless of the operation.</p> <ul style="list-style-type: none"> • Wait until the registration is complete. • Decrease the number of data logging settings.
	Data logging setting has been registered with unused folders remaining in the SD memory card.	<p>Wait until the registration is completed. Deleting the unused folders in advance can reduce the time taken for the registration.</p>

Symptom	Cause	Action
<p>During execution of the data logging function, when monitoring the logging status is attempted through USB or Ethernet connection, the communication is disconnected and the following error is displayed.</p> <ul style="list-style-type: none"> • Communication timeout "ES: 01808505" • Cannot communicate with the PLC. "ES: 0180840B" (The error code changes depending on the timing.) 	<p>The communication is performed when the load applied to the CPU module is high.</p>	<p>Starting multiple data loggings will temporarily increase the load on the service processing. This may slow down the communication response, causing a timeout error. By modifying the service processing setting in PLC Parameter, occurrence of a timeout error can be avoided. For the service processing setting, refer to the following.</p> <p>☞ User's Manual (Function Explanation, Program Fundamentals) for the CPU module used</p>

13.2.5 Troubleshooting on the data logging status

The following are examples of problems on the data logging status and corrective actions.

Symptom	Cause	Action
<p>The data logging is in the stop status.</p>	<p>Start operation has not been performed from the configuration tool.</p>	<p>Perform the start operation from the configuration tool.</p>
	<p>With an error due to a data logging registration failure detected, the CPU module was powered off and on or was reset.</p>	<p>Perform the start operation from the configuration tool. If a data logging error has occurred after the start operation, modify the configuration according to the error description.</p>

13.2.6 Troubleshooting on the data logging file transfer function

The following is an example of a problem on the data logging file transfer function and corrective action.

Symptom	Cause	Action
<p>An error such as Ethernet communication timeout occurs.</p>	<p>Reception of some files failed in UDP communication.</p>	<p>Since a load is increased during the Ethernet communication, if files are transferred simultaneously with execution of another communication function (such as MELSOFT connection and MC protocol) by UDP, some files failed to be received in the UDP communication. Transferring files through the TCP communication is recommended.</p>

Memo

APPENDICES

Appendix 1 Installing a USB Driver

To communicate with the CPU module via USB, a USB driver needs to be installed. This section describes the installation procedure of a USB driver. If multiple MELSOFT products are installed, refer to their installed location.

(1) Windows® XP

(a) Installation procedure

1. Connect a personal computer to the CPU module with a USB cable, and power on the programmable controller.
2. Select "Install from a list or specific location (Advanced)" on the "Found New Hardware Wizard" window.
3. On the next window, select "Search for the best driver in these locations". Check the "Include this location in the search" checkbox, and specify the "Easysocket\USBDrivers" folder where the configuration tool has been installed.

(b) Precautions

If the driver cannot be installed, check the following setting on Windows®. Select [Control Panel] ⇒ [System] ⇒ [Hardware], and click the [Driver Signing] button. If "Block — Never install unsigned driver software" is selected, the USB driver may not be installed. Select "Ignore - Install the software anyway and don't ask for my approval" or "Warn — Prompt me each time to choose an action", and then install the USB driver.

(2) Windows Vista®

(a) Installation procedure

1. Connect a personal computer to the CPU module with a USB cable, and power on the programmable controller.
2. Select "Locate and install driver software (recommended)" on the "Found New Hardware" window.
3. On the next window, select "Browse my computer for driver software (advanced)".
4. On the next window, select "Search for the best driver in these locations". Check the "Include subfolders" checkbox, and specify the "Easysocket\USBDrivers" folder where the configuration tool has been installed.

(b) Precautions

If "Windows can't verify the publisher of this driver software" appears on the "Windows Security" window, select "Install this driver software anyway".

(3) Windows[®] 7 and later

(a) Installation procedure

- 1.** Connect a personal computer to the CPU module with a USB cable, and power on the programmable controller.
- 2.** Select [Start] ⇒ [Control Panel] ⇒ [System and Security] ⇒ [Administrative Tools] ⇒ [Computer Management] ⇒ [Device Manager]. Right-click "Unknown device", and click "Update Driver Software".
- 3.** On the window appeared, select "Browse my computer for driver software". Then, specify the "Easysocket\USBDrivers" folder where the configuration tool has been installed on the next window.

Memo

A

Appendix 1 Installing a USB Driver

Appendix 2 Added and Changed Functions

Some functions are added to the CPU module and configuration tool. The following table lists the serial numbers of the CPU modules and software versions of the configuration tool that support those added functions.

Added function	Serial number (first five digits) of the CPU module			Version of configuration tool	Reference
	QnUDVCPU	QnUDPVCPU	LCPU		
"32-bit Windows®7" operating system	—	—	—	1.07H or later	—
Data logging file transfer function	—	—	12112 or later	1.10L or later	Page 82, Section 7.4
CC-Link IE Field Network (A link direct device can be specified as a device targeted for sampling and condition specification.)			13012 or later	1.15R or later	Page 49, Section 6.1, Page 50, Section 6.2, User's Manual (Function Explanation, Program Fundamentals) for the CPU module used
"64-bit Windows®7" operating system			—	1.18U or later	—
High-speed Universal model QCPU Universal model Process CPU			—	1.26C or later	—
Optional setting of saved files	Not supported	Not supported	15042 or later	1.30G or later	Page 127, Section 8.4.12
Stack logging file transfer					Page 92, Section 7.4.7
Transfer completion/Non-completion file distinction indication					Page 94, Section 7.4.8
"32-bit Windows®8" and "64-bit Windows®8" operating systems					—
"32-bit Windows®8.1" and "64-bit Windows®8.1" operating systems	—	—	—	1.35M or later	—
Display language switching*1				1.46Y or later	Page 47, Section 5.4
"32-bit Windows®10" and "64-bit Windows®10" operating systems				1.58L or later	—
Paste/Insert device copied in other application software				1.70Y or later	Page 119, Section 8.4.6
Data logging name read instruction (SP.LOGNAMER)	20073 or later	20073 or later	Not supported	1.84N or later	Page 173, Section 11.2
Data logging file name addition instruction (SP.LOGFILES)					Page 175, Section 11.3
Specification period logging					Page 61, Section 6.3.3

—: Functions that are not related to serial No. or software version

- *1 Configuration tools for each language are integrated into the multilingual version in 1.46Y. Display languages can be switched by this function. In versions prior to 1.46Y, version 1.06G or later supports Simplified Chinese, version 1.08J or later supports Korean, and version 1.15R or later supports Traditional Chinese (Taiwan).

Memo

A

Appendix 2 Added and Changed Functions

INDEX

A	
Auto logging by inserting an SD memory card	78
Auto logging setting	134
Available characters	157
B	
Buffer capacity	68
Buffer capacity setting	135
C	
Checking the data logging processing time	167
Checking the product information	156
Comment line	38
Common setting	133
Completion	63
Condition specification	52
Connection channel	140
Connection from a serial port	28
Connection from a USB	28
Connection from an interface board	31
Connection test	140
Continuous logging	56
CPU module	19
CPU Module Logging Configuration Tool	27
Creating a new project	103
CSV file output format	37
CSV format specifications	37
D	
Data line	41
Data logging file	64
Data logging file name addition	175
Data logging file transfer function	82
Data logging file transfer status	154
Data logging function	48
Data logging name read	173
Data logging operation at transition to RUN	77
Data logging processing time	161
Data logging setting	110
Data logging status	63
Data missing	69
Data name line	40
Data type information line	39
Deleting the data logging setting in the CPU module	147
Device batch replacement	102
Display unit	19
E	
Each scanning cycle	50
Edit item tree	99
F	
File access	81
File information line	38
File switching setting	65
File switching timing	65
File transfer diagnostics	89
File transfer error log	155
File transfer test	88
Folder structure	36
FTP setting	130
Function specifications	34
G	
Getting the configuration tool	46
GX LogViewer	27
I	
Insert device copied in other application software	119
Installing a USB driver	187
Installing the configuration tool	47
L	
List of the errors	180
Logging file operation	152
Logging status and operation	149
Logging type	56
M	
Main window	96
Menu structure	97
O	
Opening a project	103
Operating environment	33
Other functions	77
P	
Paste device copied in other application software	119
Pause	63
Processing overflow	69
Processing time	161
Programming tool	19
Project management	103
R	
Reading the data logging setting from the CPU module	143

Reading the data logging setting from the SD memory card	106
Retry	87

S

Sampling	115
Saving a project	104
Saving format	64
SD memory card	159
Searching CPU modules	141
Software	27
Specification period	123
Specification period logging	61
Standby	85
Start	63
Start from GX LogViewer	47
Start from the programming tool	47
Start from the Start menu	47
Starting the configuration tool	47
Status bar	100
Stop	63
Switching a display language	47

T

Target data	49
Time for saving data to an SD memory card	159
Time specification	50
Toolbar structure	98
Transfer data overflow	86
Transfer setup	136
Trigger	121
Trigger condition	59
Trigger logging	57
Trigger logging reset	171
Trigger logging set	171
Troubleshooting	180

U

Uninstalling the configuration tool	47
---	----

V

Value ranges by output format	42
---	----

W

Window structure	96
Wizard (display and operation)	113
Writing the data logging setting to the CPU module	145
Writing the data logging setting to the SD memory card	108

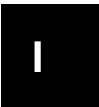

INSTRUCTION INDEX

L

LOGTRG 171
LOGTRGR 171

S

SP.LOGFILES 175
SP.LOGNAMER 173

Memo



REVISIONS

*The manual number is given on the bottom left of the back cover.

Print date	*Manual number	Revision
January 2010	SH(NA)-080893ENG-A	First edition
April 2010	SH(NA)-080893ENG-B	<p>Partial correction</p> <p>SAFETY PRECAUTIONS, Section 5.2.1, 6.3.3, 6.8, 8.4.4, 8.4.7, 8.4.12, 8.12.1, 13.1</p>
August 2010	SH(NA)-080893ENG-C	<p>Partial correction</p> <p>Section 2.3, 5.2, 5.2.1, 5.2.2, 8.4.9, 8.4.12, 8.11, Appendix 1</p> <p>Additions</p> <p>Section 8.13.3</p>
September 2010	SH(NA)-080893ENG-D	<p>Partial correction</p> <p>TERMS, Section 2.3, 5.2.1, 5.2.2, 8.6.5, Appendix 1</p> <p>Additions</p> <p>Appendix 2</p>
December 2010	SH(NA)-080893ENG-E	<p>Partial correction</p> <p>TERMS, Section 2.3, 5.2.1, Appendix 2</p>
January 2011	SH(NA)-080893ENG-F	<p>Partial correction</p> <p>TERMS, Section 1.1, 2.1, 3.1, 8.2.1, 8.2.2, 8.2.3, 8.2.4, 8.2.7, 8.3.4, 8.3.5, 8.4.1, 8.4.2, 8.4.10, 8.7, 8.8, 8.9, 8.10, 10.1.1, 10.1.2, 10.3, 12.1, 12.2, 13.1, Appendix 2</p> <p>Additions</p> <p>Section 3.4, 7.4, 7.4.1, 7.4.2, 7.4.3, 7.4.4, 7.4.5, 7.4.6, 8.4.11, 8.12, 13.2.6</p>
April 2011	SH(NA)-080893ENG-G	<p>The descriptions about the operating environment in Section 2.3 were moved to the following files included in the installers:</p> <p>[For English version software] Operating Environment for the QnUDVCPU & LCPU Logging Configuration Tool Version 1 (English Version) (BCN-P5882)</p> <p>[For Chinese version software] QnUDVCPU•LCPU 记录设置工具 Version 1 简体中文版运行环境 (BCN-P5869)</p> <p>Partial correction</p> <p>Section 6.1, 6.2, 6.5.3, Appendix 2</p>
July 2011	SH(NA)-080893ENG-H	<p>Partial correction</p> <p>INTRODUCTION, TERMS, Section 2.1.2, 7.4.6, 8.6.3, 10.1.1, 10.1.2, 10.3, 10.4, 13.1, 13.2.4</p>
September 2011	SH(NA)-080893ENG-I	<p>Partial correction</p> <p>SAFETY PRECAUTIONS, RELEVANT MANUALS, TERMS</p>
May 2012	SH(NA)-080893ENG-J	<p>Partial correction</p> <p>SAFETY PRECAUTIONS, Section 6.7</p>

Print date	*Manual number	Revision
February 2013	SH(NA)-080893ENG-K	New models of the Universal model QCPU and the LCPU have been added. New models of the LCPU have been added. <div style="border: 1px solid black; padding: 2px;">Added models</div> Q03UDVCPU, Q04UDVCPU, Q06UDVCPU, Q13UDVCPU, Q26UDVCPU, L06CPU, L26CPU
October 2013	SH(NA)-080893ENG-L	New models of the LCPU have been added. <div style="border: 1px solid black; padding: 2px;">Added models</div> L06CPU-P, L26CPU-P <div style="border: 1px solid black; padding: 2px;">Partial correction</div> INTRODUCTION, TERMS, Section 3.1, 3.3.2, 5.1, 6.2, 6.3.3, 6.4, 6.8, 7.4.6, 8.2.5, 8.3.4, 8.4.1, 8.4.4, 8.4.10, 8.4.11, 10.1.1, 10.1.2, 10.3, 10.4, 13.1, 13.2.2, Appendix 2 <div style="border: 1px solid black; padding: 2px;">Additions</div> Section 7.4.7, 7.4.8
June 2014	SH(NA)-080893ENG-M	The manual was fully revised because of the following reasons. <ul style="list-style-type: none"> • The name of configuration tool was changed from QnUDVCPU & LCPU Logging Configuration Tool to CPU Module Logging Configuration Tool. • The contents of the Operating Environment for the QnUDVCPU & LCPU Logging Configuration Tool Version 1 (English Version) (BCN-P5882) were integrated into the CPU Module Logging Configuration Tool/GX LogViewer Installation Instructions (BCN-P5999-0393).
October 2014	SH(NA)-080893ENG-N	<div style="border: 1px solid black; padding: 2px;">Partial correction</div> Section 6.8, 8.5.2, 13.1
March 2015	SH(NA)-080893ENG-O	<div style="border: 1px solid black; padding: 2px;">Added models</div> NZ1MEM-2GBSD, NZ1MEM-4GBSD, NZ1MEM-8GBSD, NZ1MEM-16GBSD <div style="border: 1px solid black; padding: 2px;">Partial correction</div> RELEVANT MANUALS, TERMS, Section 1.1, 2.1, 3.3.2, 5.1, Chapter 6, Section 9.1, 10.1.1, 10.1.2, 10.3, 10.4 <div style="border: 1px solid black; padding: 2px;">Additions</div> Section 6.8
June 2015	SH(NA)-080893ENG-P	<div style="border: 1px solid black; padding: 2px;">Partial correction</div> Section 2.3, 5.2, 5.4, 8.2.2, 8.4.6, Appendix 2
December 2015	SH(NA)-080893ENG-Q	<div style="border: 1px solid black; padding: 2px;">Partial correction</div> Section 12.1, 13.1
May 2016	SH(NA)-080893ENG-R	<div style="border: 1px solid black; padding: 2px;">Partial correction</div> TERMS, Section 8.4.5, 9.1, Appendix 2
October 2016	SH(NA)-080893ENG-S	<div style="border: 1px solid black; padding: 2px;">Partial correction</div> Section 5.4, 8.3.4, 8.3.5, 8.4.4, 8.4.7, 8.4.9, 8.4.11

Print date	*Manual number	Revision
April 2017	SH(NA)-080893ENG-T	<div data-bbox="619 226 730 255" style="border: 1px solid black; padding: 2px;">Additions</div> Section 8.4.6 <div data-bbox="619 315 810 344" style="border: 1px solid black; padding: 2px;">Partial correction</div> Appendix 2
September 2018	SH(NA)-080893ENG-U	<div data-bbox="619 412 783 441" style="border: 1px solid black; padding: 2px;">Added models</div> Q04UDPVCPU, Q06UDPVCPU, Q13UDPVCPU, Q26UDPVCPU <div data-bbox="619 501 810 530" style="border: 1px solid black; padding: 2px;">Partial correction</div> Section 1.1, 3.1, 3.4, Chapter 6, Section 6.3, 6.3.1, 6.3.2, 6.5.3, 6.6, 6.8, 6.9, 7.2, 8.4.1, 8.4.3, 10.1.1, 10.4, Chapter 11, Section 12.2, 13.2.3, Appendix 2 <div data-bbox="619 629 730 658" style="border: 1px solid black; padding: 2px;">Additions</div> Section 6.3.3, 8.4.9, 11.2, 11.3

Japanese manual version SH-080886-Y

This manual confers no industrial property rights or any rights of any other kind, nor does it confer any patent licenses. Mitsubishi Electric Corporation cannot be held responsible for any problems involving industrial property rights which may occur as a result of using the contents noted in this manual.

© 2010 MITSUBISHI ELECTRIC CORPORATION

WARRANTY

Please confirm the following product warranty details before using this product.

1. Gratis Warranty Term and Gratis Warranty Range

If any faults or defects (hereinafter "Failure") found to be the responsibility of Mitsubishi occurs during use of the product within the gratis warranty term, the product shall be repaired at no cost via the sales representative or Mitsubishi Service Company.

However, if repairs are required onsite at domestic or overseas location, expenses to send an engineer will be solely at the customer's discretion. Mitsubishi shall not be held responsible for any re-commissioning, maintenance, or testing on-site that involves replacement of the failed module.

[Gratis Warranty Term]

The gratis warranty term of the product shall be for one year after the date of purchase or delivery to a designated place. Note that after manufacture and shipment from Mitsubishi, the maximum distribution period shall be six (6) months, and the longest gratis warranty term after manufacturing shall be eighteen (18) months. The gratis warranty term of repair parts shall not exceed the gratis warranty term before repairs.

[Gratis Warranty Range]

- (1) The range shall be limited to normal use within the usage state, usage methods and usage environment, etc., which follow the conditions and precautions, etc., given in the instruction manual, user's manual and caution labels on the product.
- (2) Even within the gratis warranty term, repairs shall be charged for in the following cases.
 1. Failure occurring from inappropriate storage or handling, carelessness or negligence by the user. Failure caused by the user's hardware or software design.
 2. Failure caused by unapproved modifications, etc., to the product by the user.
 3. When the Mitsubishi product is assembled into a user's device, Failure that could have been avoided if functions or structures, judged as necessary in the legal safety measures the user's device is subject to or as necessary by industry standards, had been provided.
 4. Failure that could have been avoided if consumable parts (battery, backlight, fuse, etc.) designated in the instruction manual had been correctly serviced or replaced.
 5. Failure caused by external irresistible forces such as fires or abnormal voltages, and Failure caused by force majeure such as earthquakes, lightning, wind and water damage.
 6. Failure caused by reasons unpredictable by scientific technology standards at time of shipment from Mitsubishi.
 7. Any other failure found not to be the responsibility of Mitsubishi or that admitted not to be so by the user.

2. Onerous repair term after discontinuation of production

- (1) Mitsubishi shall accept onerous product repairs for seven (7) years after production of the product is discontinued. Discontinuation of production shall be notified with Mitsubishi Technical Bulletins, etc.
- (2) Product supply (including repair parts) is not available after production is discontinued.

3. Overseas service

Overseas, repairs shall be accepted by Mitsubishi's local overseas FA Center. Note that the repair conditions at each FA Center may differ.

4. Exclusion of loss in opportunity and secondary loss from warranty liability

Regardless of the gratis warranty term, Mitsubishi shall not be liable for compensation to:

- (1) Damages caused by any cause found not to be the responsibility of Mitsubishi.
- (2) Loss in opportunity, lost profits incurred to the user by Failures of Mitsubishi products.
- (3) Special damages and secondary damages whether foreseeable or not, compensation for accidents, and compensation for damages to products other than Mitsubishi products.
- (4) Replacement by the user, maintenance of on-site equipment, start-up test run and other tasks.

5. Changes in product specifications

The specifications given in the catalogs, manuals or technical documents are subject to change without prior notice.

TRADEMARKS

Ethernet is a registered trademark of Fuji Xerox Co., Ltd. in Japan.

Microsoft and Windows are either registered trademarks or trademarks of Microsoft Corporation in the United States and/or other countries.

The SD and SDHC logos are trademarks of SD-3C, LLC.

The company names, system names and product names mentioned in this manual are either registered trademarks or trademarks of their respective companies.

In some cases, trademark symbols such as '™' or '®' are not specified in this manual.



SH(NA)-080893ENG-U(1809)MEE

MODEL: LCPU-U-DL-E

MODEL CODE: 13JZ39

MITSUBISHI ELECTRIC CORPORATION

HEAD OFFICE : TOKYO BUILDING, 2-7-3 MARUNOUCHI, CHIYODA-KU, TOKYO 100-8310, JAPAN
NAGOYA WORKS : 1-14, YADA-MINAMI 5-CHOME, HIGASHI-KU, NAGOYA, JAPAN

When exported from Japan, this manual does not require application to the
Ministry of Economy, Trade and Industry for service transaction permission.

Specifications subject to change without notice.